

Mobile Crane Grue mobile

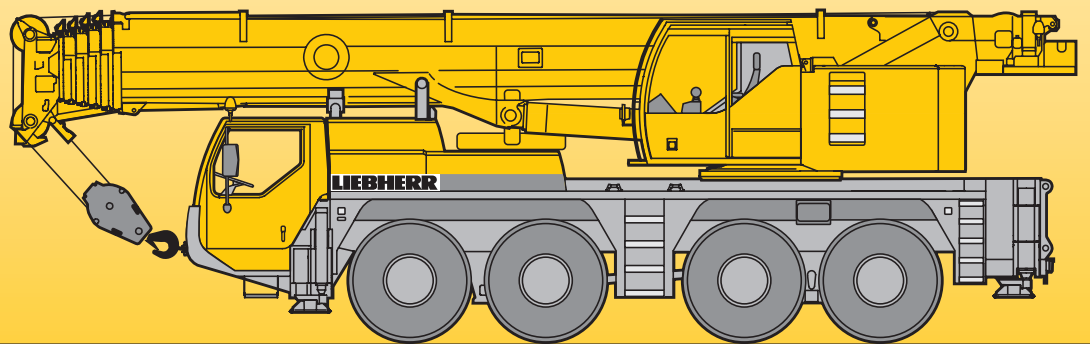



LTM 1090-4.1

Technical Data Caractéristiques techniques



LIEBHERR





Lifting capacities on telescopic boom Forces de levage à la flèche télescopique

36 - 164 ft    46300 lbs  **85%**

ft	36 ft 48 ft 60 ft 72 ft 83 ft 95 ft 107 ft 119 ft 130 ft 142 ft 154 ft 164 ft												ft	
	*													
9		150	140	140										9
10	212	150	140	139	118									10
12	146	145	137	131	118	96								12
14	134	132	126	121	115	96	82.5							14
16	124	120	117	112	108	96	81.5	61.5						16
18	116	110	109	105	101	94	79.5	61.5	54.6					18
20	108	101	102	98	94.5	91	77.5	61.5	54.5	42.9				20
23	96	88.5	90	89	85.5	82.5	74.5	61.5	53.6	42.9				23
26	83	77.5	79	79	78	75	71.5	58.5	51.5	42.4	34			26
29	63.5	63	70	70.5	68	66.5	63	54.7	48.8	41.2	33.5	25.1		29
32			62	62.5	60.5	59	55.9	50.9	45.9	39.5	32.7	25.1	21.8	32
35			55.5	55.7	54.8	52.7	50	47	43.2	37.6	31.5	25.1	21.8	35
38			50.2	50.8	49.6	47.5	45	43	40.7	35.8	30.3	24.8	21.5	38
44				42.1	41.3	39.5	37.4	36.4	34.5	32.4	27.8	23.4	20.6	44
50				34.8	34.8	33.4	31.8	31.6	29.8	28.5	25.6	21.9	19.4	50
56					29.5	28.7	28.2	27.5	26	24.6	23.6	20.5	18.1	56
62						24.8	25.3	24	22.7	21.7	21.3	19.1	16.9	62
68						21.4	22.1	21.1	20.4	19.6	18.7	17.8	15.8	68
74							19.3	18.7	18.7	17.6	16.6	16.5	14.8	74
80							17.1	16.8	16.6	15.7	15.2	15	13.9	80
86								15.2	14.7	14.5	14.1	13.4	13	86
92								13.9	13.1	12.9	12.7	11.8	11.7	92
98								12.5	12	11.6	11.2	10.5	10.4	98
104									11.1	10.4	10	9.2	9.2	104
110									10.1	9.4	8.9	8.3	8.2	110
116										8.5	8.1	7.4	7.3	116
122											7.3	6.6	6.5	122
128											6.7	5.9	5.8	128
134												5.3	5.2	134
140												4.7	4.7	140
146													4.2	146

* over rear / en arrière

TAB 150315 / 150301





36 - 164 ft    37500 lbs  **85%**

ft	36 ft 48 ft 60 ft 72 ft 83 ft 95 ft 107 ft 119 ft 130 ft 142 ft 154 ft 164 ft												ft	
9	150	140	140											9
10	150	140	139	118										10
12	145	137	131	118	96									12
14	131	126	121	115	96	82.5								14
16	119	117	112	108	96	81.5	61.5							16
18	109	109	105	101	94	79.5	61.5	54.6						18
20	99.5	101	98	94	91	77.5	61.5	54.5	42.9					20
23	85.5	87	87.5	83.5	80	74.5	61.5	53.6	42.9					23
26	75	76	74.5	71	69	65	58.5	51.5	42.4	34				26
29	62.5	67	64.5	63	60.5	57	53.6	48.8	41.2	33.5	25.1			29
32		58.7	57.6	55.8	53.2	50.3	48.2	45.4	39.5	32.7	25.1	21.8		32
35		52.1	51.5	49.7	47.4	44.9	43.4	41.1	37.6	31.5	25.1	21.8		35
38		46.2	46.2	44.6	42.6	40.5	39.6	37	35.6	30.3	24.8	21.5		38
44			37.8	37	35.4	34.4	33.5	31.5	30.2	27.8	23.4	20.6		44
50			31.2	31.1	29.8	29.7	28.5	26.9	26	24.9	21.9	19.4		50
56				26.3	25.5	25.8	24.4	23.7	22.8	21.7	20.5	18.1		56
62					22	22.4	21.4	21.2	20	19.2	18.7	16.9		62
68					19	19.5	19.3	18.6	17.8	17.5	16.6	15.7		68
74						16.9	17.3	16.3	16.1	15.6	14.6	14.3		74
80						14.9	15.2	14.5	14.3	13.8	12.8	12.6		80
86							13.3	13.2	12.5	12.1	11.3	11.1		86
92							11.9	11.7	11	10.6	9.7	9.6		92
98							10.7	10.4	9.7	9.3	8.6	8.5		98
104								9.3	8.7	8.3	7.6	7.5		104
110								8.5	7.8	7.4	6.7	6.6		110
116									7.1	6.6	5.9	5.9		116
122										5.9	5.3	5.2		122
128										5.3	4.6	4.6		128
134											4	4		134
140											3.4	3.5		140
146												2.9		146





TAB 150303

Lifting capacities on telescopic boom

Forces de levage à la flèche télescopique

    85%													
ft	36 ft	48 ft	60 ft	72 ft	83 ft	95 ft	107 ft	119 ft	130 ft	142 ft	154 ft	164 ft	ft
9	150	140	140										9
10	150	140	139	118									10
12	144	137	131	118	96								12
14	129	126	121	114	96	82.5							14
16	115	115	109	99.5	91	81.5	61.5						16
18	102	100	94.5	87	81.5	74.5	61.5	54.6					18
20	89	84	81	76.5	71.5	66.5	60.5	54.1	42.9				20
23	71	69	66.5	63	59.3	55.8	52.8	49.3	42.9				23
26	59.1	57.7	55.9	53.4	50.5	47.7	46.6	43.7	40.8	34			26
29	49.3	49.3	48.1	46.1	43.8	42.9	40.7	38	36.7	33.5	25.1		29
32		42.8	41.9	40.2	38.5	37.9	35.9	34.5	32.6	30.6	25.1	21.8	32
35		37.5	36.7	35.4	33.9	33.5	32	31	29.4	27.2	25.1	21.8	35
38		32.7	32.5	31.7	30	29.8	29.1	27.7	26.8	25.2	24	21.5	38
44			26.1	26.4	24.3	25	24.1	23.2	22.2	21.2	19.9	19.1	44
50			21.1	21.9	20.7	21	20.2	19.5	18.4	17.6	16.4	16.1	50
56				18.1	17.9	17.8	17.1	16.5	15.5	14.8	13.7	13.4	56
62					15	15	14.6	14	13.1	12.5	11.5	11.2	62
68					12.6	12.7	12.4	12	11.2	10.6	9.6	9.5	68
74						10.8	10.5	10.3	9.5	9	8.1	8	74
80						9.3	9	8.7	8.1	7.7	6.8	6.7	80
86							7.8	7.6	7	6.6	5.7	5.6	86
92							6.8	6.6	6	5.6	4.8	4.7	92
98							6	5.7	5.1	4.8	4	3.9	98
104								5	4.4	4	3.2	3.1	104
110								4.4	3.7	3.4	2.6	2.5	110
116									3.1	2.8			116
122										2.2			122



TAB 150309

    85%													
ft	36 ft	48 ft	60 ft	72 ft	83 ft	95 ft	107 ft	119 ft	130 ft	142 ft	154 ft	164 ft	ft
9	150	140	140										9
10	150	140	139	118									10
12	143	137	131	118	96								12
14	129	126	120	111	96	82.5							14
16	114	111	104	95.5	87.5	81	61.5						16
18	99	94.5	90	83.5	77	72.5	61	54.6					18
20	84	80	77	72.5	67.5	63	59.5	53.9	42.9				20
23	67	65	63	59.6	56.1	52.8	49.9	48	42.9				23
26	55.7	54.5	52.9	50.6	47.7	46.8	44	41.1	38.2	34			26
29	46.4	46.5	45.4	43.5	41.4	40.6	38.2	36.5	34.5	32.1	25.1		29
32		40	39.2	37.6	36	35.4	33.8	32.5	31	28.5	25.1	21.8	32
35		34.8	34.2	33.7	31.6	31.2	30.5	29	28	25.9	24.5	21.8	35
38		30.4	30.3	30.3	27.9	28.4	27.5	26.3	25.2	23.8	22.5	21.3	38
44			24.2	24.7	23.4	23.5	22.5	21.7	20.5	19.6	18.3	17.9	44
50			19.5	20.2	19.7	19.5	18.7	18	17	16.2	15	14.7	50
56				16.7	16.5	16.4	15.7	15.1	14.2	13.5	12.4	12.2	56
62					13.8	13.8	13.3	12.8	12	11.3	10.3	10.1	62
68					11.5	11.6	11.3	10.9	10.1	9.6	8.6	8.5	68
74						9.8	9.5	9.2	8.6	8.1	7.2	7	74
80						8.4	8.2	7.9	7.3	6.9	6	5.8	80
86							7	6.8	6.2	5.8	4.9	4.8	86
92							6.1	5.9	5.3	4.9	4	3.9	92
98							5.4	5.1	4.5	4.1	3.2	3.1	98
104								4.4	3.8	3.4	2.6	2.5	104
110								3.7	3.1	2.8			110
116									2.5				116

TAB 150310

Lifting capacities on telescopic boom

Forces de levage à la flèche télescopique

 36 - 60 ft

 0°
 46300 lbs
85%

ft	36 ft			48 ft			60 ft			ft
9		51.9			53.2			54		9
10		51.4			52.7			53.5		10
12		45.2			46.6			47.4		12
14		40.1			41.5			42.4		14
16		35.8			37.2			38.1		16
18		32.2			33.8			34.6		18
20		29			30.5			31.4		20
23		25			26.6			27.5		23
26		21.7			23.4			24.3		26
29		19			20.7			21.6		29
32					18.4			19.3		32
35					16.4			17.3		35
38					14.4			15.6		38
44								12.3		44
50								9.6		50

0° = over rear / en arrière

tyre size / dimensions de pneumatiques: 16.00 R 25 / 20.5 R 25

TAB 150137

Lifting heights Hauteurs de levage

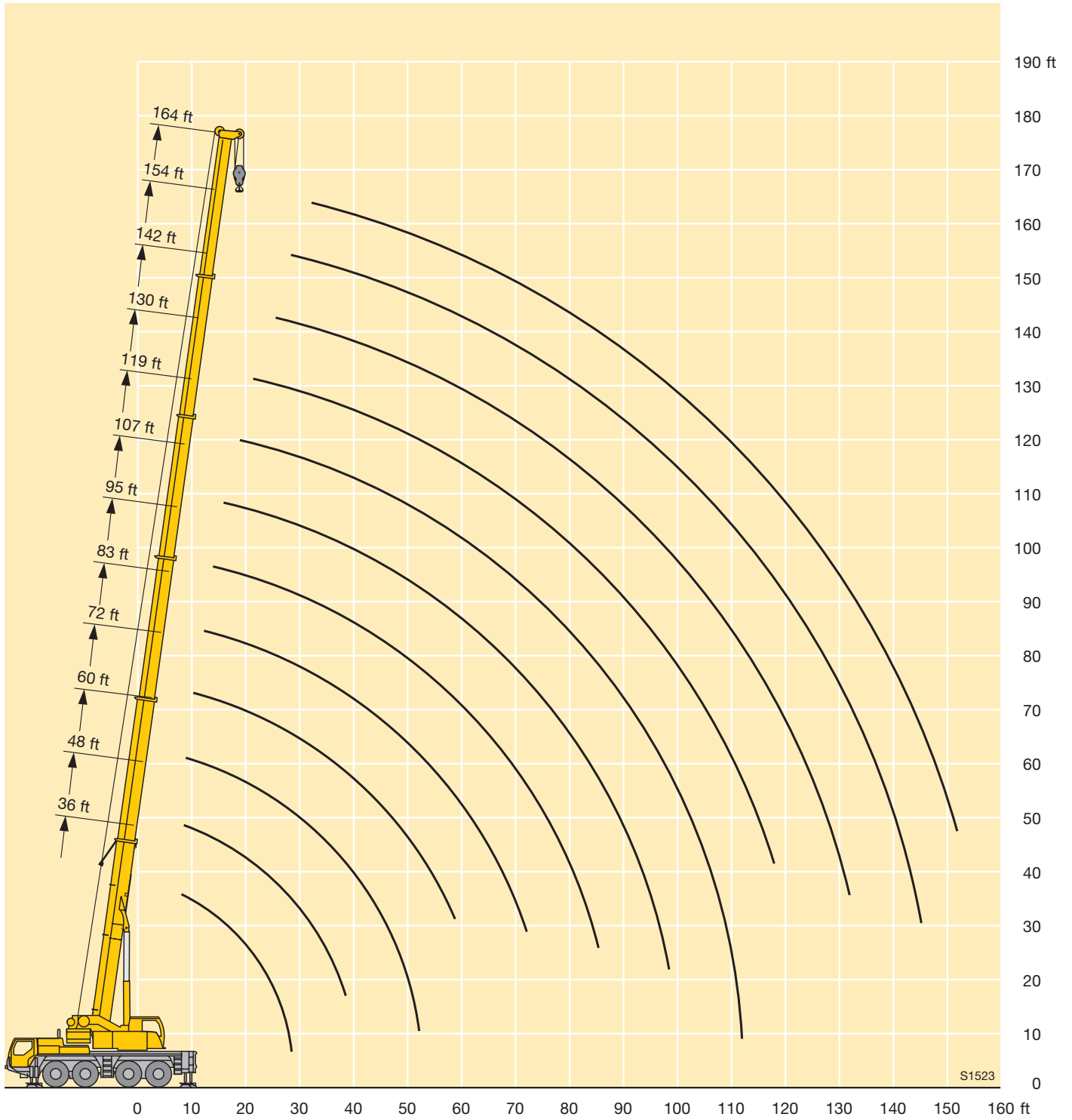

Lifting capacities on the folding jib

Forces de levage à la fléchette pliante



ft	36 ft			83 ft			95 ft			107 ft			119 ft			130 ft			142 ft			154 ft			164 ft			ft		
	34 ft			34 ft			34 ft			34 ft			34 ft			34 ft			34 ft			34 ft								
	0°	20°	40°	0°	20°	40°	0°	20°	40°	0°	20°	40°	0°	20°	40°	0°	20°	40°	0°	20°	40°	0°	20°	40°	0°	20°	40°			
10	25.1																										10			
12	25.1																											12		
14	25.1	22.3																										14		
16	25.1	22.3		25.1																								16		
18	25.1	22.2		25.1			25.1																					18		
20	25.1	21.9		25.1			25.1			25.1																		20		
23	25.1	20.8	16.5	25.1			25.1			25.1																		23		
26	23.9	19.7	16.4	25.1			25.1			25.1			23.8															26		
29	22.3	18.8	15.9	25.1	22.3		25.1			25.1			23.8			20.4												29		
32	20.6	17.9	15.4	25.1	21.8		25.1	21.6		25.1			23.8			20.4			17									32		
35	19.1	17.2	15	25.1	21.1	16.5	25.1	21.2		25.1	20.7		23.6			20.4			17			12.6						35		
38	17.7	16.4	14.7	25.1	20.4	16.2	25.1	20.6	16.1	25.1	20.3		23.3	19.4		20.3			17			12.6			10.7			38		
44	15.4	14.9	14	24.7	19.2	15.7	24.8	19.5	15.7	24.2	19.4	15.5	22.4	18.8	15	19.9	17.5		16.9	16		12.6			10.7			44		
50	13.4	13.4	13.1	23.2	18.2	15.2	23.6	18.5	15.2	23	18.5	15.2	21.5	18	14.9	19.4	17.1	14.3	16.5	15.6	12.6	12.6	11.9		10.7	10.4		50		
56	11.8	12.3	12.1	21.2	17.3	14.8	22.1	17.7	14.8	21.8	17.7	14.8	20.7	17.3	14.6	18.6	16.6	14.2	15.8	14.7	12.6	12.3	11.6	10.7	10.5	10.2	9.5	56		
62				19.3	16.5	14.4	20.5	16.9	14.5	20.6	17	14.5	19.7	16.7	14.3	17.6	16.1	14	14.9	13.8	12.5	11.8	11	10.4	10.2	9.8	9.4	62		
68				17.6	15.6	14.1	19	16.1	14.2	19.1	16.3	14.2	18.2	16.2	14.1	16.5	15.4	13.8	14	13	12.2	11.2	10.5	9.9	9.8	9.4	9.1	68		
74				16.1	14.7	13.6	17.5	15.4	14	17.2	15.6	13.9	16	15.6	13.8	15.3	14.7	13.5	13.1	12.3	11.6	10.6	10	9.5	9.3	8.9	8.8	74		
80				14.8	13.8	13.1	16	14.6	13.6	15.3	14.9	13.7	14.2	14.8	13.6	13.8	13.8	13.2	12.3	11.6	11	10	9.5	9.1	8.8	8.5	8.4	80		
86				13.7	13	12.6	14.5	13.8	13.1	13.6	14.1	13.3	13	13.3	13.2	12.2	12.9	12.7	11.6	10.9	10.4	9.4	9	8.8	8.4	8.2	8.1	86		
92				12.7	12.4	12.2	13	13.1	12.6	12.2	12.8	12.8	11.8	11.9	12.4	10.8	11.6	12.1	10.8	10.4	9.9	8.9	8.6	8.5	8	7.8	7.8	92		
98				11.8	11.9	11.9	11.4	11.9	12.1	10.8	11.4	11.7	10.6	11.1	11.1	10	10.3	10.8	9.6	9.8	9.5	8.5	8.2	8.2	7.7	7.5	7.5	98		
104				10.9	11.2		10.2	10.6	10.8	9.6	10	10.3	9.4	9.9	10.2	9.3	9.2	9.6	8.6	9.1	9	8.1	7.9	7.9	7.4	7.2	7.2	104		
110							9.2	9.5		8.6	8.9	9.2	8.4	8.8	9.1	8.4	8.6	8.7	7.7	8.2	8.5	7.7	7.6	7.6	7	6.9	6.9	110		
116							8.3	8.5		7.7	8	8.1	7.5	7.9	8.1	7.6	7.9	8.1	7.3	7.3	7.7	7	7.3	7.3	6.7	6.6	6.6	116		
122										6.9	7.2		6.7	7.1	7.2	6.8	7.1	7.3	6.9	6.9	7	6.2	6.7	6.9	6.1	6.3	6.4	122		
128										6.2	6.3		6.1	6.3		6.3	6.5	6.6	6.3	6.5	6.6	5.5	6	6.3	5.4	5.8	6	128		
134													5.8	5.9		5.9	6	6.1	5.6	6	6.1	4.9	5.3	5.5	4.8	5.2	5.4	134		
140													5.6	5.7		5.5	5.6		5	5.3	5.4	4.4	4.7	4.9	4.2	4.6	4.8	140		
146																4.9	5.1		4.5	4.7	4.8	3.8	4.1	4.3	3.7	4	4.2	146		
152																			4	4.2		3.3	3.6	3.7	3.2	3.5	3.7	152		
158																						3.5	3.7		2.7	3	3.2	158		
164																						3.1	3.1		2.3	2.6		164		
170																									1.9	2.1		170		
176																									1.6	1.7		1.4	1.6	176

TAB 150321 / 150331 / 150341

Lifting capacities on the folding jib Forces de levage à la fléchette pliante



ft	36 ft			95 ft			107 ft			119 ft			130 ft			142 ft			154 ft			164 ft			ft
	62 ft			62 ft			62 ft			62 ft			62 ft			62 ft			62 ft						
	0°	20°	40°	0°	20°	40°	0°	20°	40°	0°	20°	40°	0°	20°	40°	0°	20°	40°	0°	20°	40°	0°	20°	40°	
10	9																							10	
12	9																							12	
14	9																							14	
16	9																							16	
18	9																							18	
20	9																							20	
23	9																							23	
26	8.8			9																				26	
29	8.6	7.3		9			8.5																	29	
32	8.4	7.3		9			8.5																	32	
35	8.1	7.3		9			8.5			8.3		8.3												35	
38	7.9	7.2		9			8.5			8.3		8.3												38	
44	7.5	6.9		8.9	7.3		8.5			8.3		8.3		7.8			6.8							44	
50	7	6.5	5.8	8.6	7.3		8.4	7		8.2	7	8.3		7.8			6.8				6.1			50	
56	6.4	6.2	5.7	8.3	7.2		8.1	7		8	6.9	8.2	7	7.8	6.8		6.8				6.1			56	
62	5.9	5.9	5.6	8	6.9	5.8	7.9	6.9	5.8	7.8	6.8	8	6.9	7.7	6.8		6.8	6.3			6.1	5.8		62	
68	5.4	5.6	5.4	7.7	6.7	5.8	7.6	6.7	5.8	7.6	6.6	5.6	7.8	6.8	5.6	7.6	6.7	6.8	6.3		6.1	5.8		68	
74	5	5.2	5.3	7.5	6.5	5.7	7.4	6.5	5.7	7.4	6.5	5.6	7.5	6.6	5.6	7.4	6.5	5.6	6.8	6.2	5.3	6.1	5.8	74	
80	4.6	4.8	5	7.2	6.3	5.6	7.2	6.3	5.6	7.2	6.3	5.6	7.3	6.4	5.6	7.2	6.3	5.6	6.7	6	5.3	6.1	5.8	5.1	80
86				6.9	6.1	5.5	6.9	6.1	5.5	6.9	6.1	5.5	7.2	6.2	5.6	7.1	6.2	5.5	6.6	5.9	5.3	6	5.7	5.1	86
92				6.5	6	5.5	6.6	6	5.4	6.7	6	5.4	7	6.1	5.5	6.9	6	5.4	6.5	5.8	5.3	5.9	5.6	5.1	92
98				6.2	5.8	5.4	6.3	5.8	5.4	6.5	5.9	5.4	6.8	6	5.4	6.7	5.9	5.3	6.4	5.7	5.2	5.8	5.5	5.1	98
104				5.8	5.6	5.4	6	5.7	5.3	6.2	5.7	5.3	6.6	5.8	5.3	6.6	5.8	5.3	6.2	5.6	5.2	5.8	5.4	5.1	104
110				5.5	5.4	5.3	5.7	5.5	5.3	5.9	5.6	5.3	6.4	5.7	5.3	6.4	5.7	5.3	6	5.5	5.1	5.6	5.3	5.1	110
116				5.2	5.1	5.1	5.4	5.3	5.2	5.6	5.4	5.3	6.3	5.6	5.3	6.2	5.6	5.2	5.8	5.4	5.1	5.4	5.2	5	116
122				5	4.9	4.9	5.1	5.1	5.1	5.4	5.2	5.2	6.1	5.5	5.2	6.1	5.5	5.2	5.7	5.3	5.1	5.2	5	4.9	122
128				4.8	4.7	4.8	4.8	4.8	4.9	5.1	5	5	5.9	5.4	5.2	5.8	5.4	5.2	5.5	5.2	5.1	5	4.9	4.8	128
134				4.5	4.5	4.6	4.5	4.6	4.7	4.9	4.8	4.9	5.7	5.4	5.2	5.3	5.3	5.2	5.2	5.1	5	4.8	4.7	4.7	134
140				4.4	4.4		4.3	4.4	4.5	4.6	4.6	4.7	5.3	5.3	5.2	5	5.2	5.2	4.7	4.9	4.9	4.5	4.5	4.6	140
146							4.1	4.2	4.3	4.4	4.5	4.5	4.8	5.2	5.2	4.7	4.8	5	4.2	4.7	4.8	4	4.4	4.4	146
152							3.9	4		4.2	4.3	4.4	4.4	4.8	5	4.4	4.6	4.7	3.7	4.3	4.6	3.5	4.2	4.3	152
158										4.1	4.1		4.2	4.3	4.5	4	4.4	4.5	3.3	3.8	4.2	3.1	3.7	4.1	158
164										3.9	3.9		4	4.1	4.3	3.5	3.9	4.2	2.9	3.4	3.7	2.7	3.2	3.6	164
170										3.8	3.9		3.6	3.8	3.9	3.1	3.5	3.7	2.5	3	3.2	2.3	2.8	3.1	170
176													3.2	3.4		2.7	3	3.1	2.1	2.5	2.7	1.9	2.4	2.7	176
182													2.8			2.3	2.6		1.7	2.1	2.2	1.5	2	2.2	182
188																2	2.2			1.7	1.7		1.6	1.8	188
194																1.7									194

TAB 150321 / 150331 / 150341

Lifting heights Hauteurs de levage

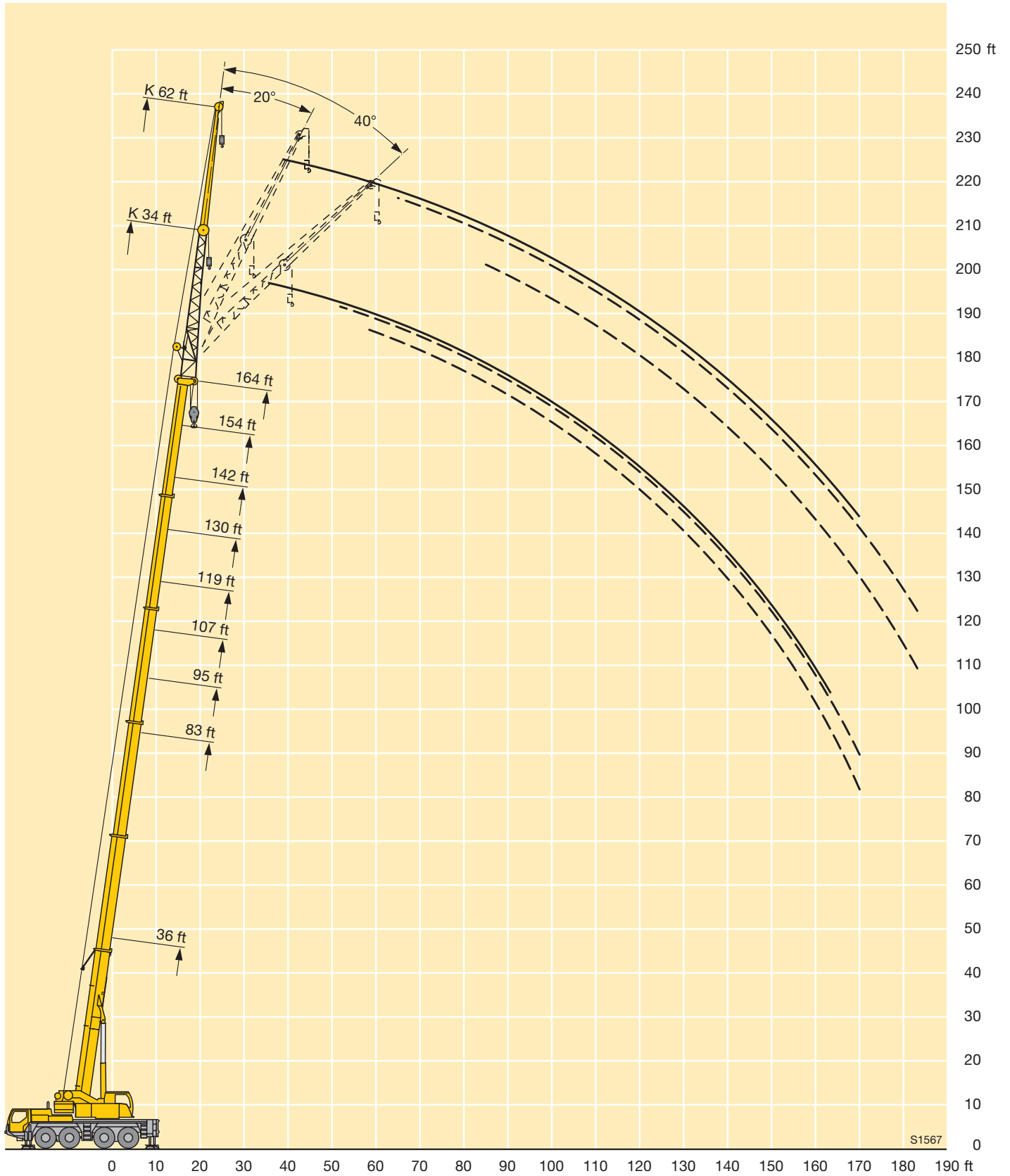

Lifting capacities on the hydraulically variable folding jib

Forces de levage à la flèche pliante à variation hydraulique



ft	36 ft			83 ft			95 ft			107 ft			119 ft			130 ft			142 ft			154 ft			164 ft			ft	
	34 ft			34 ft			34 ft			34 ft			34 ft			34 ft			34 ft			34 ft							
	0°	20°	40°	0°	20°	40°	0°	20°	40°	0°	20°	40°	0°	20°	40°	0°	20°	40°	0°	20°	40°	0°	20°	40°	0°	20°	40°		
12	25.1																										12		
14	25.1	22.3		25.1																								14	
17	25.1	22.3		25.1			25.1																					17	
20	25.1	21.9		25.1			25.1			25.1																		20	
23	25.1	20.8	16.5	25.1			25.1			25.1																		23	
26	23.9	19.7	16.4	25.1			25.1			25.1			23.8															26	
29	22.3	18.8	15.9	25.1	22.3		25.1			25.1			23.8			20.4												29	
32	20.6	17.9	15.4	25.1	21.8		25.1	21.6		25.1			23.8			20.4			17									32	
35	19.1	17.2	15	25.1	21.1	16.4	25.1	21.2		25.1	20.6					20.3			17									35	
38	17.7	16.4	14.7	25.1	20.4	16.2	25.1	20.6	16.1	25.1	20.3					20.2			17			12.5			10.7			38	
44	15.4	14.9	14	24.7	19.2	15.7	24.8	19.5	15.7	24.1	19.3	15.5	22.3	18.8	15	19.8	17.5		16.9	16		12.6			10.7			44	
50	13.4	13.4	13.1	23.1	18.2	15.2	23.6	18.5	15.2	22.9	18.4	15.2	21.4	18	14.9	19.3	17.1	14.3	16.4	15.5	13.8	12.5	11.6		10.7	10.2		50	
56	11.8	12.3	12.1	21	17.3	14.8	22	17.7	14.8	21.8	17.7	14.8	20.6	17.3	14.6	18.6	16.6	14.2	15.7	14.6	13.6	12.2	11.4	10.4	10.5	10	9.5	56	
62				19.2	16.4	14.4	20.4	16.9	14.5	20.5	17	14.5	19.6	16.7	14.3	17.6	16.1	14	14.7	13.7	12.9	11.7	10.9	10.2	10.1	9.7	9.3	62	
68				17.5	15.5	14	18.8	16.1	14.2	18.9	16.3	14.2	17.9	16.2	14.1	16.4	15.4	13.8	13.8	12.9	12.2	11	10.3	9.8	9.6	9.3	9	68	
74				16.1	14.6	13.6	17.3	15.3	13.9	16.9	15.5	13.9	15.7	15.6	13.8	15.1	14.6	13.5	13	12.1	11.6	10.4	9.8	9.4	9.2	8.8	8.7	74	
80				14.8	13.7	13	15.8	14.4	13.5	15	14.8	13.6	14	14.7	13.6	13.5	13.7	13.1	12.2	11.4	11	9.9	9.3	9	8.7	8.4	8.3	80	
86				13.6	12.9	12.5	14.3	13.7	13	13.4	13.9	13.2	12.9	13	13.2	11.9	12.8	12.6	11.4	10.8	10.4	9.3	8.9	8.7	8.3	8	8	86	
92				12.6	12.3	12.1	12.8	13	12.5	11.9	12.5	12.7	11.6	11.8	12.1	10.6	11.3	11.9	10.5	10.2	9.9	8.8	8.5	8.4	7.9	7.7	7.7	92	
98				11.8	11.8	11.8	11.2	11.7	11.9	10.6	11.1	11.5	10.4	10.9	11	9.8	10	10.6	9.3	9.7	9.5	8.3	8.1	8.1	7.5	7.3	7.3	98	
104				10.8	10.9		10	10.3	10.5	9.4	9.8	10.1	9.2	9.7	10	9.1	9	9.4	8.3	8.9	9	8	7.8	7.7	7.2	7.1	7	104	
110							9	9.2		8.4	8.7	8.9	8.2	8.6	8.9	8.2	8.5	8.6	7.6	7.9	8.3	7.5	7.4	7.4	6.9	6.8	6.8	110	
116							8.1	8.3		7.5	7.8	7.9	7.3	7.7	7.9	7.3	7.7	7.9	7.1	7.1	7.4	6.8	7.1	7.1	6.5	6.5	6.5	116	
122										6.7	6.9		6.5	6.8	7	6.6	6.9	7.1	6.6	6.7	6.8	6	6.5	6.7	5.8	6.1	6.3	122	
128										5.9	6.1		6	6.1		6.2	6.3	6.4	6	6.3	6.4	5.3	5.7	6	5.2	5.6	5.8	128	
134													5.7	5.7		5.8	5.9	5.9	5.4	5.6	5.9	4.7	5	5.3	4.5	4.9	5.2	134	
140													5.5	5.6		5.2	5.4		4.8	5	5.2	4.1	4.4	4.6	4	4.3	4.5	140	
146																4.7	4.8		4.3	4.5	4.6	3.6	3.9	4	3.4	3.8	4	146	
152																4.2			3.7	3.9		3	3.3	3.5	3	3.2	3.4	152	
158																			3.2	3.4		2.5	2.8		2.5	2.7	2.9	158	
164																			2.8	2.9		2.1	2.3		2	2.2	2.3	164	
170																						1.7	1.8		1.6	1.8		170	
176																								1.4					176

TAB 150351 / 150361 / 150371

Lifting capacities on the hydraulically variable folding jib

Forces de levage à la fléchette pliante à variation hydraulique



ft	36 ft			95 ft			107 ft			119 ft			130 ft			142 ft			154 ft			164 ft			ft		
	62 ft			62 ft			62 ft			62 ft			62 ft			62 ft			62 ft								
	0°	20°	40°	0°	20°	40°	0°	20°	40°	0°	20°	40°	0°	20°	40°	0°	20°	40°	0°	20°	40°	0°	20°	40°			
12	9																							12			
14	9																							14			
17	9																							17			
20	9																							20			
23	9																							23			
26	8.8			9																				26			
29	8.6	7.3		9			8.5																	29			
32	8.4	7.3		9			8.5																	32			
35	8.1	7.3		9			8.5			8.3														35			
38	7.9	7.2		9			8.5			8.3		8.3												38			
44	7.5	6.9		8.9	7.3		8.5			8.3		8.3		7.8										44			
50	7	6.5	5.8	8.6	7.3		8.3	7		8.1	7	8.2		7.8			6.8					6.1		50			
56	6.4	6.2	5.7	8.3	7.2		8.1	7		8	6.9	8.1	7	7.7	6.8		6.8					6.1		56			
62	5.9	5.9	5.6	8	6.9	5.8	7.9	6.9	5.8	7.8	6.8	8	6.9	7.7	6.8		6.8	6.3				6.1	5.8	62			
68	5.4	5.6	5.4	7.7	6.7	5.8	7.6	6.7	5.8	7.6	6.6	5.6	7.8	6.7	5.6	7.5	6.7					6.8	6.3	68			
74	5	5.2	5.3	7.5	6.5	5.7	7.4	6.5	5.7	7.4	6.5	5.6	7.5	6.6	5.6	7.4	6.5	5.6	6.8	6.2	5.3	6.1	5.8	74			
80	4.6	4.8	5	7.2	6.3	5.6	7.1	6.3	5.6	7.2	6.3	5.6	7.3	6.4	5.6	7.2	6.3	5.6	6.7	6	5.3	6.1	5.8	5.1	80		
86				6.8	6.1	5.6	6.8	6.1	5.5	6.9	6.1	5.5	7.2	6.2	5.6	7	6.2	5.5	6.6	5.9	5.3	6	5.7	5.1	86		
92				6.5	6	5.5	6.6	6	5.4	6.6	6	5.4	7	6.1	5.5	6.9	6	5.4	6.5	5.8	5.3	5.9	5.6	5.1	92		
98				6.1	5.8	5.4	6.2	5.8	5.4	6.4	5.8	5.4	6.8	6	5.4	6.7	5.9	5.3	6.3	5.7	5.2	5.8	5.5	5.1	98		
104				5.7	5.5	5.3	5.9	5.7	5.3	6.1	5.7	5.3	6.6	5.8	5.3	6.6	5.8	5.3	6.2	5.6	5.2	5.7	5.4	5.1	104		
110				5.4	5.3	5.2	5.6	5.4	5.3	5.8	5.5	5.3	6.4	5.7	5.3	6.4	5.7	5.3	6	5.5	5.1	5.5	5.2	5.1	110		
116				5.2	5	5	5.3	5.2	5.2	5.5	5.3	5.2	6.3	5.6	5.3	6.2	5.6	5.2	5.8	5.4	5.1	5.3	5.1	5	116		
122				4.9	4.8	4.9	5	5	5	5.3	5.1	5.1	6.1	5.5	5.2	6.1	5.5	5.2	5.6	5.3	5.1	5.1	4.9	4.9	122		
128				4.7	4.6	4.7	4.7	4.7	4.8	5	4.9	4.9	5.9	5.4	5.2	5.6	5.4	5.2	5.4	5.1	5	4.9	4.8	4.7	128		
134				4.5	4.4	4.5	4.5	4.5	4.6	4.8	4.7	4.8	5.6	5.4	5.2	5.1	5.3	5.2	5	4.9	4.6	4.6	4.6	4.6	134		
140				4.3	4.3		4.2	4.3	4.4	4.5	4.5	4.6	5.1	5.3	5.2	4.9	5.1	5.1	4.5	4.8	4.8	4.3	4.5	4.5	140		
146				4	4.1	4.2	4.3	4.3	4.5	4.7	4.7	5.1	5.2	4.6	4.6	5	4	4.6	4.7	3.7	4.3	4.4			146		
152							3.8	3.9		4.1	4.2	4.3	4.3	4.6	4.8	4.2	4.5	4.5	3.5	4.1	4.5	3.3	3.9	4.2	152		
158										4	4		4.1	4.2	4.3	3.8	4.2	4.4	3.1	3.6	4	2.8	3.4	3.9	158		
164										3.8	3.8		3.8	4	4.2	3.3	3.7	3.9	2.6	3.1	3.5	2.4	3	3.4	164		
170										3.7	3.8		3.4	3.6	3.6	2.9	3.3	3.4	2.2	2.7	3	2	2.5	2.9	170		
176													3	3.1				2.5	2.8	2.9	1.8	2.3	2.5	1.7	2.1	2.4	176
182														2.6				2.1	2.4		1.5	1.8	2		1.7	2	182
188																		1.8	1.9			1.4	1.5			1.5	188
194																		1.5								1.5	194

TAB 150351 / 150361 / 150371

Lifting heights Hauteurs de levage

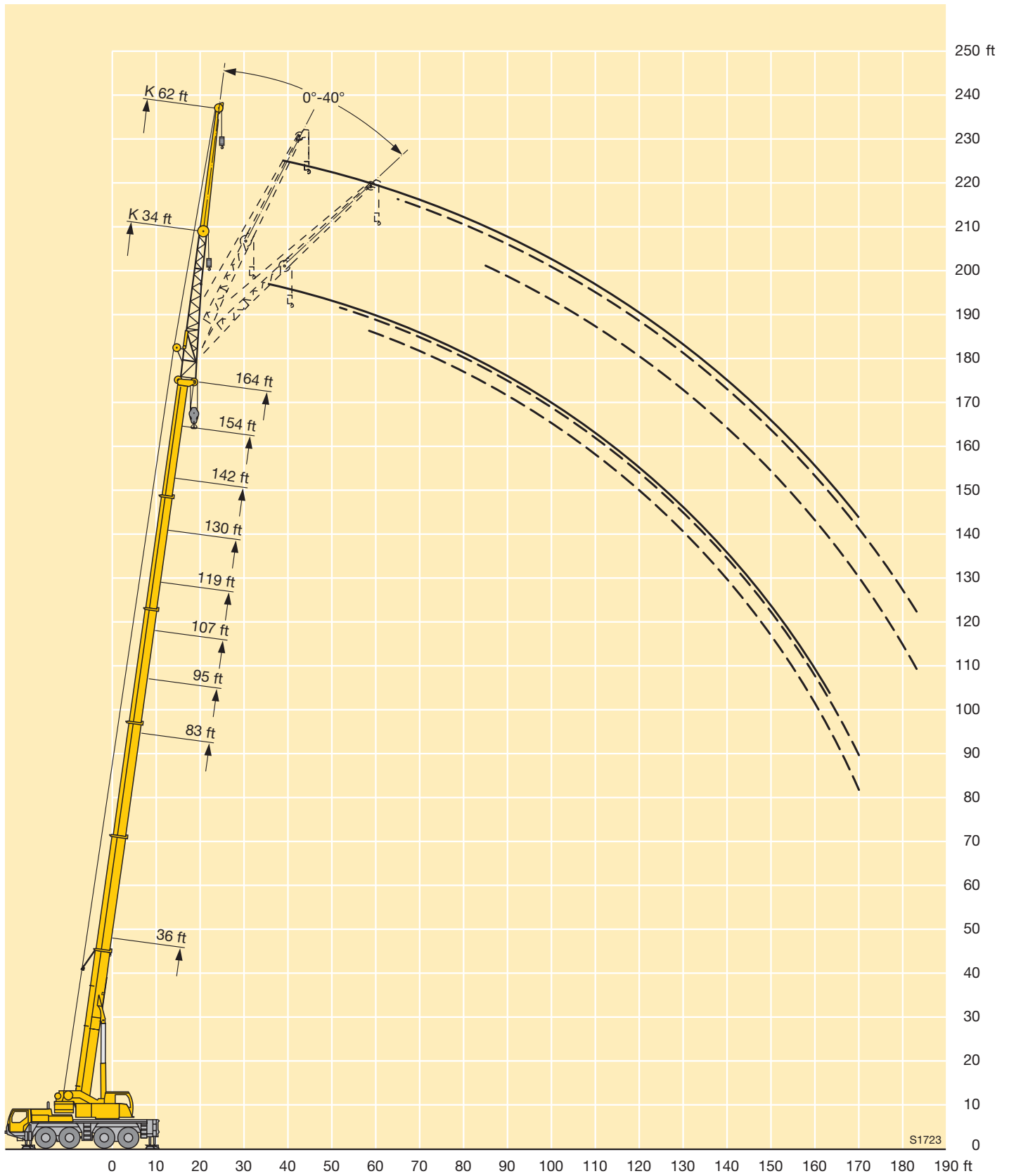

Lifting capacities on the folding jib with boom extension

Forces de levage à la fléchette pliante avec télescope rallongé



ft	36 ft + 23 ft			130 ft + 23 ft			142 ft + 23 ft			154 ft + 23 ft			164 ft + 23 ft			ft
	34 ft			34 ft			34 ft			34 ft			34 ft			
	0°	20°	40°	0°	20°	40°	0°	20°	40°	0°	20°	40°	0°	20°	40°	
10	9.2															10
12	9.2															12
14	9.2															14
16	9.2															16
18	9.2	8.7														18
20	9.2	8.7														20
23	9.2	8.7														23
26	8.9	8.7	8.3													26
29	8.6	8.7	8.3													29
32	8.1	8.4	8.3	9.2												32
35	7.7	8	8.1	9.2			8.5									35
38	7.3	7.6	7.9	9.2			8.5			8						38
44	6.6	6.8	7.1	9.2	8.7		8.5			8			7			44
50	6	6.2	6.4	9.2	8.7	8.3	8.5	8.5		8	8		7			50
56	5.4	5.6	5.8	9.1	8.7	8.3	8.5	8.4	8	8	8	7.5	7	7		56
62	4.9	5.1	5.3	8.8	8.4	8.1	8.4	8.2	7.9	8	7.8	7.5	7	7	6.8	62
68	4.4	4.7	4.8	8.4	8	7.8	8.2	7.9	7.7	7.8	7.6	7.4	7	6.9	6.7	68
74	4	4.2	4.4	8	7.6	7.4	7.9	7.6	7.4	7.7	7.3	7.2	6.8	6.7	6.6	74
80	3.7	3.8		7.5	7.2	7.1	7.5	7.2	7.1	7.4	7	7	6.7	6.5	6.4	80
86				7.1	6.9	6.8	7.2	6.9	6.7	7.1	6.8	6.7	6.5	6.2	6.1	86
92				6.8	6.5	6.5	6.8	6.6	6.5	6.8	6.5	6.4	6.2	6	5.9	92
98				6.5	6.2	6.2	6.5	6.3	6.2	6.5	6.3	6.2	5.9	5.8	5.7	98
104				6.1	6	5.9	6.2	6	5.9	6.2	6	5.9	5.7	5.6	5.5	104
110				5.8	5.7	5.7	5.9	5.8	5.7	6	5.8	5.7	5.4	5.3	5.3	110
116				5.6	5.5	5.4	5.7	5.6	5.5	5.7	5.6	5.5	5.2	5.1	5.1	116
122				5.3	5.2	5.2	5.4	5.3	5.3	5.5	5.4	5.3	5	4.9	4.9	122
128				5.1	5	5	5.2	5.1	5.1	5.2	5.2	5.2	4.8	4.7	4.8	128
134				4.8	4.8	4.8	5	4.9	4.9	4.7	4.9	5	4.4	4.6	4.6	134
140				4.6	4.6	4.6	4.7	4.7	4.8	4.1	4.5	4.7	3.9	4.3	4.4	140
146				4.4	4.4	4.5	4.3	4.5	4.6	3.6	4	4.2	3.4	3.8	4.1	146
152				4.2	4.2	4.3	3.8	4.1	4.2	3.1	3.5	3.7	2.9	3.3	3.5	152
158				3.8	4		3.4	3.6	3.8	2.7	3	3.2	2.5	2.8	3	158
164				3.4	3.6		2.9	3.2	3.2	2.3	2.6	2.7	2.1	2.4	2.5	164
170				3	3.1		2.5	2.7	2.7	1.8	2.1	2.2	1.7	2	2.1	170
176				2.6	2.6		2.1	2.3		1.4	1.7	1.7		1.6	1.7	176
182							1.7	1.9								182
188							1.4	1.5								188

TAB 150381 / 150391 / 150401

Lifting capacities on the folding jib with boom extension

Forces de levage à la fléchette pliante avec télescope rallongé



ft	36 ft + 23 ft			130 ft + 23 ft			142 ft + 23 ft			154 ft + 23 ft			164 ft + 23 ft			ft
	62 ft			62 ft			62 ft			62 ft			62 ft			
	0°	20°	40°	0°	20°	40°	0°	20°	40°	0°	20°	40°	0°	20°	40°	
16	5.8															16
18	5.8															18
20	5.8															20
23	5.8															23
26	5.8															26
29	5.8															29
32	5.8	5.3														32
35	5.8	5.3		5.8												35
38	5.6	5.3		5.8			5.3									38
44	5.3	5.3		5.8			5.3			5.1						44
50	5	5	4.6	5.8			5.3			5.1			4.2			50
56	4.7	4.7	4.6	5.8			5.3			5.1			4.2			56
62	4.4	4.4	4.5	5.8	5.3		5.3	5.1		5.1			4.1			62
68	4.1	4.2	4.3	5.8	5.3		5.3	5.1		5.1	4.9		4.1	4.1		68
74	3.8	3.9	4.1	5.6	5.2	4.6	5.3	5.1		5.1	4.8		4	4.1		74
80	3.5	3.7	3.8	5.5	5	4.6	5.3	4.9	4.4	5	4.8	4.4	3.9	4.1		80
86	3.2	3.4	3.6	5.3	4.9	4.6	5.1	4.8	4.4	4.9	4.6	4.4	3.9	4.1	4.1	86
92	3	3.2	3.4	5.1	4.7	4.5	5	4.6	4.4	4.8	4.5	4.3	3.8	4	4.1	92
98	2.8	3	3.1	4.9	4.6	4.4	4.8	4.5	4.3	4.7	4.4	4.2	3.7	4	4	98
104	2.6	2.7	2.7	4.7	4.4	4.2	4.7	4.4	4.2	4.5	4.2	4.1	3.7	3.9	3.9	104
110	2.4	2.5		4.6	4.3	4.1	4.5	4.2	4.1	4.4	4.1	4	3.7	3.9	3.9	110
116				4.4	4.2	4.1	4.4	4.1	4	4.3	4	3.9	3.6	3.8	3.8	116
122				4.2	4	3.9	4.2	4	3.9	4.2	3.9	3.9	3.6	3.7	3.7	122
128				4	3.9	3.8	4.1	3.9	3.8	4	3.8	3.8	3.5	3.6	3.6	128
134				3.9	3.8	3.7	3.9	3.8	3.7	3.9	3.7	3.7	3.4	3.5	3.5	134
140				3.7	3.6	3.6	3.8	3.6	3.6	3.8	3.6	3.6	3.4	3.4	3.4	140
146				3.5	3.5	3.5	3.6	3.5	3.5	3.6	3.5	3.5	3.3	3.3	3.3	146
152				3.4	3.4	3.4	3.5	3.4	3.4	3.3	3.4	3.4	3.1	3.2	3.2	152
158				3.3	3.2	3.3	3.3	3.3	3.3	2.9	3.3	3.3	2.7	3.1	3.1	158
164				3.1	3.1	3.2	3.2	3.2	3.2	2.5	3.1	3.2	2.3	2.9	3	164
170				3	3	3.1	2.9	3.1	3.1	2.1	2.7	3	1.9	2.5	2.9	170
176				2.9	2.9	3	2.5	2.9	3	1.8	2.3	2.6	1.5	2.1	2.5	176
182				2.6	2.8	2.9	2.1	2.5	2.7	1.5	1.9	2.2		1.7	2.1	182
188				2.2	2.5	2.6	1.8	2.1	2.3		1.6	1.8			1.7	188
194				1.9	2.1		1.4	1.8	1.9							194
200				1.6	1.8											200

TAB 150381 / 150391 / 150401

Lifting heights Hauteurs de levage

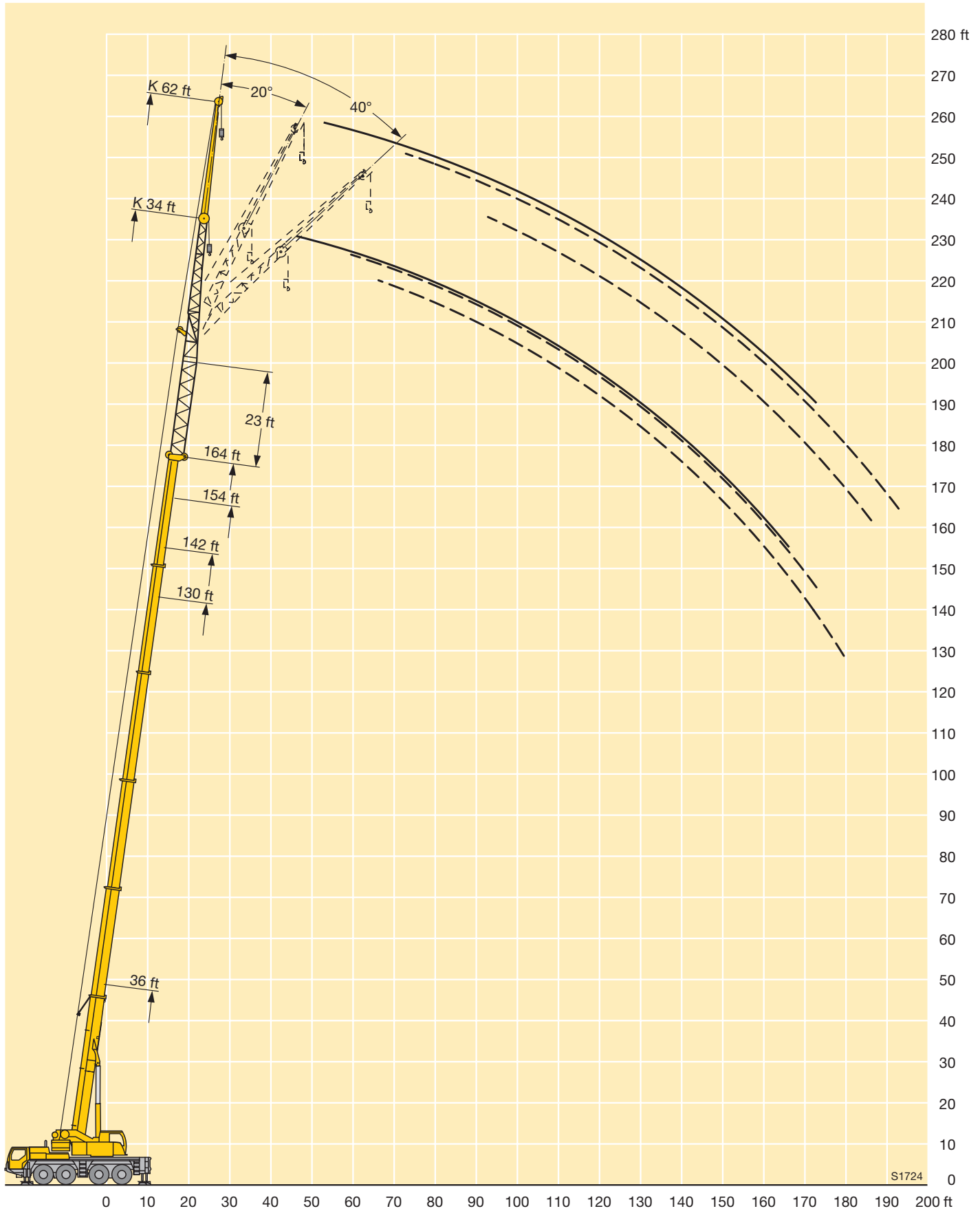

Lifting capacities on the hydraulically variable folding jib with boom extension

Forces de levage à la fléchette pliante à variation hydraulique avec télescope rallongé



ft	36 ft + 23 ft			130 ft + 23 ft			142 ft + 23 ft			154 ft + 23 ft			164 ft + 23 ft			ft
	62 ft			62 ft			62 ft			62 ft			62 ft			
	0°	20°	40°	0°	20°	40°	0°	20°	40°	0°	20°	40°	0°	20°	40°	
16	5.8															16
18	5.8															18
20	5.8															20
23	5.8															23
26	5.8															26
29	5.8															29
32	5.8	5.3														32
35	5.8	5.3		5.8												35
38	5.6	5.3		5.8			5.3									38
44	5.3	5.3		5.8			5.3			4.9						44
50	5	5	4.6	5.8			5.3			4.9			3.9			50
56	4.7	4.7	4.6	5.8			5.3			4.9			3.9			56
62	4.4	4.4	4.5	5.8	5.3		5.3	5.1		4.9			3.9			62
68	4.1	4.2	4.3	5.7	5.3		5.3	5.1		4.9	4.9		3.9	3.9		68
74	3.8	3.9	4.1	5.5	5.1	4.6	5.3	5		4.9	4.8		3.8	3.9		74
80	3.5	3.7	3.8	5.3	5	4.6	5.2	4.8	4.4	4.9	4.7	4.4	3.8	3.9		80
86	3.2	3.4	3.6	5.2	4.8	4.6	5	4.7	4.4	4.8	4.5	4.4	3.7	3.9	3.9	86
92	3	3.2	3.4	5	4.6	4.4	4.9	4.5	4.4	4.7	4.4	4.3	3.6	3.9	3.9	92
98	2.8	3	3.1	4.8	4.5	4.3	4.7	4.4	4.2	4.6	4.3	4.1	3.6	3.8	3.9	98
104	2.6	2.7	2.7	4.6	4.3	4.2	4.6	4.3	4.1	4.4	4.2	4	3.5	3.8	3.8	104
110	2.4	2.5		4.4	4.2	4.1	4.4	4.1	4	4.3	4.1	3.9	3.5	3.7	3.8	110
116				4.2	4.1	4	4.3	4	3.9	4.2	3.9	3.8	3.4	3.6	3.7	116
122				4.1	3.9	3.9	4.1	3.9	3.8	4	3.8	3.8	3.4	3.6	3.6	122
128				3.9	3.8	3.7	3.9	3.8	3.7	3.9	3.7	3.7	3.3	3.5	3.5	128
134				3.7	3.6	3.6	3.8	3.7	3.6	3.8	3.6	3.6	3.3	3.4	3.4	134
140				3.6	3.5	3.5	3.6	3.5	3.5	3.6	3.5	3.5	3.2	3.3	3.3	140
146				3.4	3.3	3.4	3.5	3.4	3.4	3.5	3.4	3.4	3.1	3.2	3.2	146
152				3.2	3.2	3.2	3.3	3.3	3.3	3.1	3.3	3.3	2.9	3.1	3.1	152
158				3.1	3.1	3.1	3.2	3.1	3.2	2.7	3.2	3.2	2.5	2.9	3	158
164				3	2.9	3	3	3	3.1	2.3	2.9	3.1	2.1	2.7	2.9	164
170				2.8	2.9	2.9	2.6	2.9	3	1.9	2.5	2.9	1.7	2.3	2.7	170
176				2.7	2.7	2.8	2.3	2.7	2.9	1.6	2.1	2.4		1.9	2.3	176
182				2.4	2.6	2.7	1.9	2.3	2.5		1.7	2		1.5	1.9	182
188				2	2.3	2.4	1.5	1.9	2.1			1.6			1.5	188
194				1.7	1.9			1.6	1.7							194
200				1.4	1.6											200

TAB 150411 / 150421 / 150431

Lifting capacities on the hydraulically variable folding jib with boom extension

Forces de levage à la fléchette pliante à variation hydraulique avec télescope rallongé



ft	36 ft + 23 ft			130 ft + 23 ft			142 ft + 23 ft			154 ft + 23 ft			164 ft + 23 ft			ft
	34 ft			34 ft			34 ft			34 ft			34 ft			
	0°	20°	40°	0°	20°	40°	0°	20°	40°	0°	20°	40°	0°	20°	40°	
10	9.2															10
12	9.2															12
14	9.2															14
16	9.2															16
18	9.2	8.7														18
20	9.2	8.7														20
23	9.2	8.7														23
26	8.9	8.7	8.3													26
29	8.6	8.7	8.3													29
32	8.1	8.4	8.3	9.2												32
35	7.7	8	8.1	9.2			8.5									35
38	7.3	7.6	7.9	9.2			8.5									38
44	6.6	6.8	7.1	9.2	8.7		8.5			8						44
50	6	6.2	6.4	9.1	8.7	8.3	8.5	8.3		7.9	7.8		7			50
56	5.4	5.6	5.8	8.9	8.6	8.2	8.4	8.2	7.8	7.9	7.8	7.5	7	7		56
62	4.9	5.1	5.3	8.6	8.3	8	8.3	8	7.7	7.8	7.7	7.4	6.9	7	6.8	62
68	4.4	4.7	4.8	8.2	7.8	7.6	8.1	7.7	7.5	7.7	7.4	7.2	6.8	6.8	6.7	68
74	4	4.2	4.4	7.8	7.4	7.3	7.7	7.4	7.2	7.5	7.2	7	6.7	6.6	6.5	74
80	3.7	3.8		7.3	7.1	6.9	7.4	7	6.9	7.2	6.9	6.8	6.5	6.3	6.2	80
86				6.9	6.7	6.6	7	6.7	6.6	6.9	6.6	6.5	6.3	6.1	6	86
92				6.6	6.3	6.3	6.6	6.4	6.3	6.6	6.3	6.2	6	5.8	5.8	92
98				6.3	6.1	6	6.3	6.1	6	6.3	6.1	6	5.8	5.6	5.5	98
104				5.9	5.8	5.7	6	5.8	5.8	6	5.8	5.8	5.5	5.4	5.3	104
110				5.7	5.5	5.5	5.7	5.6	5.6	5.8	5.6	5.6	5.2	5.2	5.1	110
116				5.4	5.3	5.2	5.5	5.4	5.3	5.6	5.4	5.3	5	4.9	4.9	116
122				5.1	5	5	5.2	5.1	5.1	5.3	5.2	5.2	4.8	4.7	4.8	122
128				4.9	4.8	4.8	5	4.9	4.9	5	5	5	4.6	4.6	4.6	128
134				4.6	4.6	4.6	4.8	4.7	4.7	4.5	4.7	4.8	4.2	4.4	4.4	134
140				4.4	4.4	4.5	4.5	4.5	4.6	3.9	4.3	4.5	3.7	4.1	4.2	140
146				4.2	4.2	4.2	4.1	4.3	4.4	3.4	3.7	4	3.1	3.5	3.8	146
152				4	4	4.1	3.6	3.9	4	2.9	3.2	3.4	2.7	3	3.3	152
158				3.6	3.8		3.1	3.4	3.5	2.4	2.7	2.9	2.2	2.6	2.8	158
164				3.1	3.3		2.7	2.9	3	2	2.3	2.5	1.8	2.1	2.3	164
170				2.7	2.9		2.3	2.5	2.5	1.6	1.9	2		1.7	1.9	170
176				2.3	2.4		1.8	2				1.5				176
182							1.5	1.6								182

TAB 150411 / 150421 / 150431

Lifting heights Hauteurs de levage

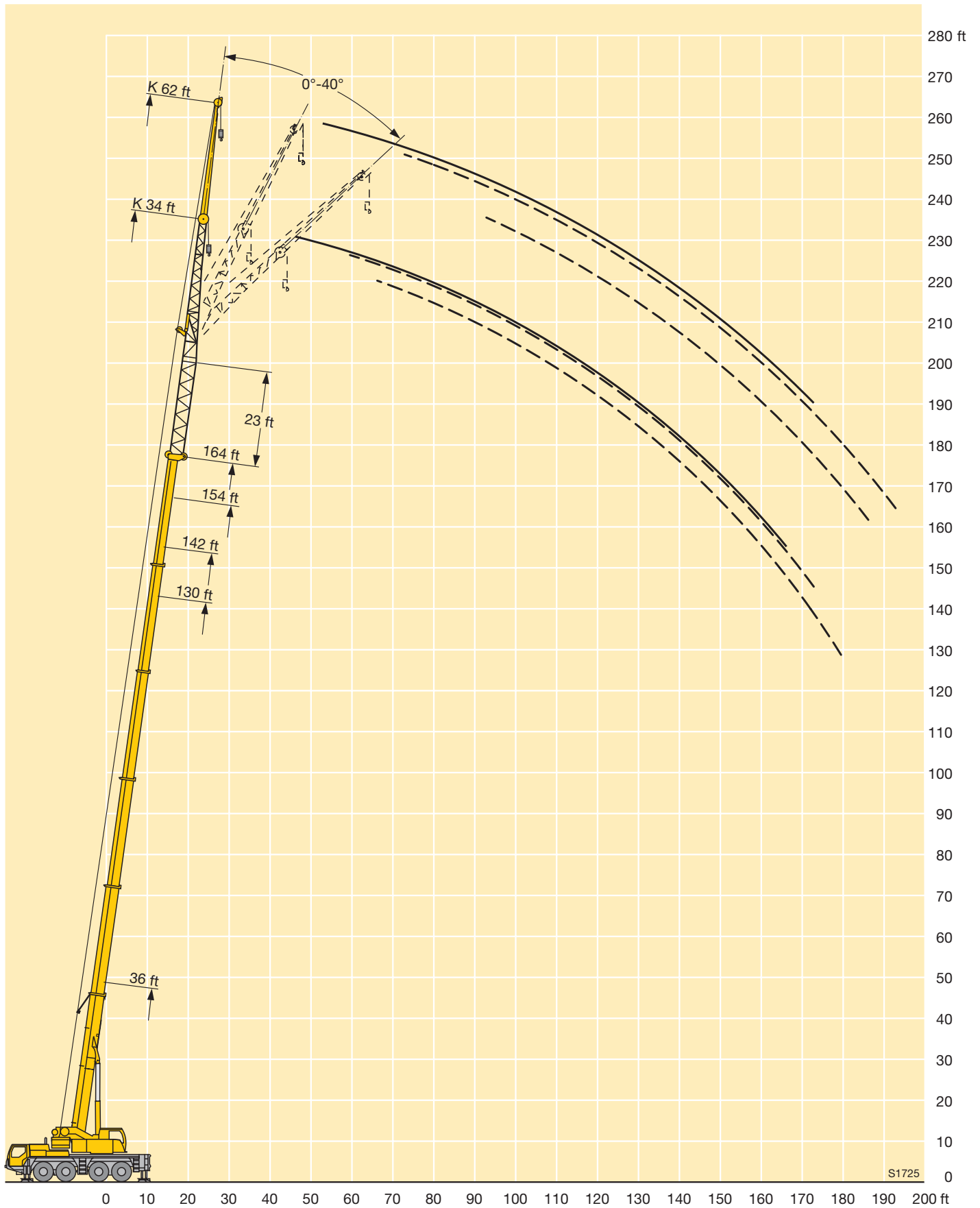

Dimensions Encombrement

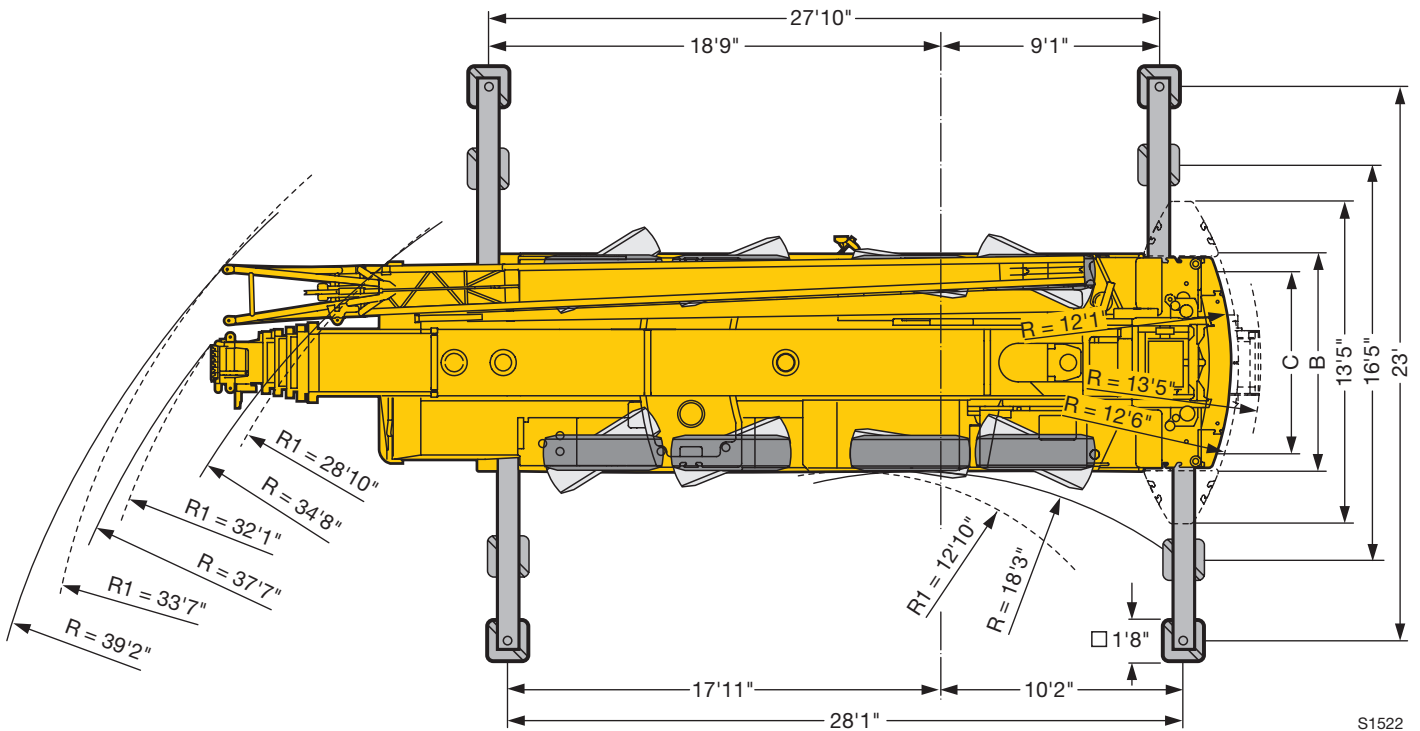
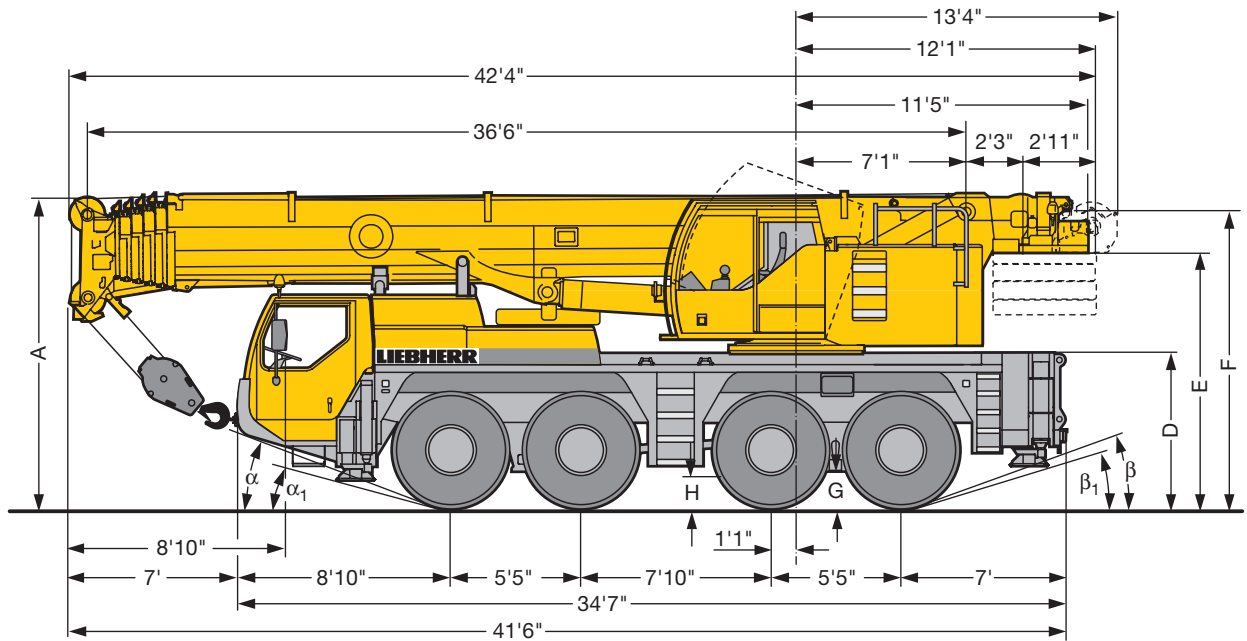

S1522

R₁ = All-wheel steering / Direction toutes roues

Dimensions / Encombrement

	A	A	B	C	D	E	F	G	H	α	α_1	β	β_1
16.00 R 25	13'	12'6" *	9'9"	7'7"	6'4"	10'6"	12'2"	1'5"	1'6"	20°	15°	20°	17°
20.5 R 25	13'	12'6"	9'9"	8'	6'4"	10'6"	12'2"	1'5"	1'6"	20°	15°	20°	17°

* lowered / abaissé

Weights Poids



Axle Essieu lbs	1	2	3	4	Total weight (lbs) Poids total lbs
	26400	26400	26400	26400	105600 ¹⁾

¹⁾ with 14800 lbs counterweight / avec contrepoids 14800 lbs



Load (kips) Forces de levage kips	No. of sheaves Poulies	No. of lines Brins	Weight lbs Poids lbs
176.3	7	14	1100
128.7	5	10	1100
84.4	3	7	992
35.3	1	3	606
12.5	-	1	309

Working speeds Vitesses



		1	2	3	4	5	6	7	8	9	10	11	12	R 1	R 2	
16.00 R 25 20.5 R 25		3.5	4.5	5.8	7.5	9.5	12.2	16	20.6	26.5	34	43.2	50	3.8	4.9	53.1 %
		1.6	2.1	2.6	3.4	4.3	5.5	7.2	9.3	11.9	15.4	19.5	25	1.7	2.2	61.7 %



Drive Mécanismes	infinitely variable en continu	Rope diameter / Rope length Diamètre du câble / Longueur du câble	Max. single line pull Effort au brin maxi.
	0 – 410 ft/min single line ft/min au brin simple	0'7" / 853 ft	12800 lbs
	0 – 410 ft/min single line ft/min au brin simple	0'7" / 853 ft	12800 lbs
	0 – 1.7 rpm		
	approx. 50 seconds to reach 83° boom angle env. 50 s jusqu'à 83°		
	approx. 330 seconds for boom extension from 36 ft – 164 ft env. 330 s pour passer de 36 ft – 164 ft		

Equipment Équipement

Crane carrier

Frame	Self-manufactured, weight-optimized and torsion resistant box-type design of high-tensile structural steel.
Outriggers	4-point supporting system, hydraulically telescopic into horizontal and vertical direction. Automatic levelling of crane. Electronic inclination indicator.
Engine	6-cylinder Diesel, make Liebherr, type D846 A7, watercooled, output 350 kW (476 h.p.) at 1900 rpm, max. torque 1637 lbs-ft at 1200 – 1500 rpm. Exhaust emissions acc. to 97/68/EG stage 3 and EPA/CARB Tier 3. Fuel reservoir: 106 gallons.
Transmission	ZF 12-speed gear box with automatic control system AS-TRONIC. ZF-intarder fitted directly to the gear. Two-stage transfer case with lockable transfer differential.
Axles	Welded design, made of high-tensile fine grained steel. All Axles steerable. Axles 2, 3 and 4 are planetary axles with differential locks.
Suspension	All axles are mounted on hydropneumatic suspension and are lockable hydraulically.
Tyres	8 tyres, size: 16.00 R 25.
Steering	ZF-servocom power steering, dual circuit system, with hydraulic servo system and auxiliary pump circuit. At road travel, the 4 th axle is steered electrohydraulically, and fixed for straight travel from 18.6 mph onwards. Steering acc. to EG directive 70/311/EWG.
Brakes	Service brake: Dual circuit, all-wheel servo-air brake. Parking brake: Spring brake actuator, acting on the wheels of the 1 st , 2 nd and 3 rd axle. Sustained-action brakes: Engine brake as exhaust retarder with Liebherr additional brake system ZBS. Intarder on gear. ABV in conjunction with ASR. Brakes acc. to EG directives 71/320 EWG.
Driver's cab	Spacious, steel made, corrosion resistant cab, cataphoretic dip-primed, on resilient suspension with hydraulic shock absorbers, sound and heat absorbing internal panelling acc. to EG directive, safety glazing, operating and control instruments, comfortably equipped.
Electrical system	Modern data bus technique, 24 Volt DC, 2 batteries of 170 Ah each, lighting according to traffic regulations.

Crane superstructure

Frame	Self-manufactured, cataphoretic dip-primed weight-optimized and torsion resistant welded design of high-tensile structural steel; linked by a triple-row roller slewing ring to the carrier for continuous rotation.
Crane engine	4-cylinder Diesel, make Liebherr, type D934S A6, watercooled, output 145 kW (197 h.p.) at 1800 rpm, max. torque 678 lbs-ft at 1100 rpm – 1500 rpm. Exhaust emissions acc. to 97/68/EG stage 3 and EPA/CARB Tier 3. Fuel reservoir: 74 gallons.

Crane drive	Diesel-hydraulic, with 1 axial piston variable displacement pump, with servo-control and capacity control, 1 double gear pump, open controlled oil circuits. Compact hydraulic drive flanged to the Diesel engine. Drive assembly completely enclosed for noise abatement.
Control	Electric "Load Sensing" control, simultaneous operation of 4 working motions, 2 self-centering hand control levers (joy-stick type).
Hoist gear	Axial piston fixed displacement motor, Liebherr hoist drum with integrated planetary gear and spring-loaded static brake. Hoist gear is driven through a controlled open oil circuit.
Luffing gear	1 differential ram with safety check valves.
Slewing gear	Axial piston fixed displacement motor, planetary gear, spring-loaded static brake. Slewing gear invertible from released to locked as a standard feature.
Crane cab	All-steel construction, entirely galvanized, powder coated, with safety glazing, operating and control instruments, comfortably equipped, cab tiltable backwards.
Safety devices	LICCON safe load indicator, test system hoist limit switch, safety valves to prevent pipe and hose ruptures.
Telescopic boom	Buckling and torsion resistant design of high-tensile structural steel, oviform boom profile, 1 base section and 5 telescopic sections. All telescopic sections hydraulically extendable independent of one another. Rapid-cycle telescoping system "Telematik". Boom length: 36 ft – 164 ft.
Counterweight	14800 lbs basic counterweight.
Electrical system	Modern data bus technique, 24 Volt DC, 2 batteries of 170 Ah each.

Additional equipment

Swing-away jib	34 ft – 62 ft long, mountable to the telescopic boom at 0°, 20° or 40°. Hydraulic ram for operating the swing-away jib from 0° – 40° (option).
Telescopic boom extension	23 ft long lattice section, thus 23 ft higher pinning point for swing-away jib.
2nd hoist gear	For two-hook operation or for operation with swing-away jib if the hoist rope shall remain reeved.
Additional counterweight	31500 lbs for a total counterweight of 46300 lbs.
Tyres	8 tyres, size 20.5 R 25.
Drive 8 x 8	Additional drive of the 1 st axle.

Other items of equipment available on request.

Equipment Équipement

Châssis porteur

Cadre	Construction en caisse résistante à la torsion et optimisée en poids réalisée par Liebherr en acier de construction à grain fin très rigide.
Calage	Dispositif de calage horizontal et vertical en 4 points, entièrement déployable hydrauliquement. Nivellement automatique du calage. Indicateurs électroniques d'inclinaison.
Moteur	Moteur diesel, 6 cylindres, fabriqué par Liebherr, de type D846 A7, à refroidissement par eau, de 350 kW (476 ch) à 1900 rpm, couple max. 1637 lbs-ft à 1200 – 1500 rpm. Emissions des gaz d'échappement conformes aux directives 97/68/EG partie 3 et EPA/CARB Tier 3. Capacité du réservoir à carburant: 106 gallons.
Boîte de vitesse	Boîte de vitesses ZF à 12 rapports, mécanisme automatisé à commande AS-TRONIC. Ralentisseur hydrodynamique ZF directement accouplé à la boîte. Boîte de transfert à 2 étages avec blocage de différentiel.
Essieux	Construction soudée en acier à haute résistance fins grains. Tous les essieux directeurs. Essieux 2, 3 et 4 planétaires avec blocage différentiel.
Suspension	Suspension hydropneumatique sur tous les essieux. Chaque essieu peut être bloqué hydrauliquement.
Pneumatiques	8 pneus de taille: 16.00 R 25.
Direction	Direction hydraulique ZF-servocom, à deux circuits, assistée hydrauliquement, avec pompe auxiliaire entraînée par essieu. Lors de déplacement routier, le 4ème essieu est dirigé électrohydrauliquement, et fixé en marche directe à partir de 18,6 mph. Direction conforme aux directives européennes 70/311/CE.
Freins	Freins de service: servofrein à air comprimé, à 2 circuits. Frein à main: ressort accumulé agissant sur les roues des essieux 1, 2 et 3. Freins continus: frein moteur par clapet sur échappement avec système de ralentissement Liebherr ZBS. Ralentisseur hydrodynamique accouplé à la boîte de vitesses. ABV avec contrôle ASR. Freins conformes aux directives européennes 71/320 CE.
Cabine du conducteur	Cabine spacieuse en tôle d'acier, traitement anticorrosion par bain de cataphorèse, avec suspension élastique et amortisseurs hydrauliques, revêtement intérieur avec isolation phonique et thermique selon les directives européennes, glaces de sécurité, appareils de commande et de contrôle, équipement confortable.
Installation électrique	Technique moderne de transmission de données par BUS de données, courant continu 24 Volts, 2 batteries de 170 Ah chacune, éclairage conforme au code de la route.

Partie tournante

Cadre	Construction soudée résistante à la torsion et optimisée en poids réalisée par Liebherr en acier de construction à grain fin très rigide. Couronne d'orientation à rouleaux à 3 rangées permettant une rotation illimitée sert de pièce de liaison avec le châssis de la grue.
--------------	--

Moteur	Moteur diesel Liebherr, 4 cylindres, de type D934S A6, à refroidissement par eau, de 145 kW (197 ch) à 1800 rpm, couple max. 678 lbs-ft à 1100 rpm – 1500 rpm. Emissions des gaz d'échappement conformes aux directives 97/68/EG partie 3 et EPA/CARB Tier 3. Capacité du réservoir à carburant: 74 gallons.
Entraînement de la grue	Diesel hydraulique avec 1 pompes à débit variable à piston axiaux, servocommande et régulation de la puissance, 1 double pompe à engrenages, circuits hydrauliques ouverts et régulés. Entraînement hydraulique compact, accouplé directement au moteur Diesel, mécanisme d'entraînement total fermé pour une bonne insonorisation.
Direction	Direction électrique «Load Sensing», 4 mouvements de travail dirigeable simultanément, deux leviers de commande à 4 positions et à autocentrage.
Mécanisme de levage	Moteur à cylindrée constante et à pistons axiaux. Treuil de marque Liebherr équipé d'un engrenage planétaire et d'un frein d'arrêt commandé par ressort. L'entraînement du treuil de levage s'effectue en circuit régulé et fermé.
Mécanisme de relevage	1 vérin différentiel avec soupapes de retenu.
Dispositif de rotation	Moteur à cylindrée constante à pistons axiaux, engrenage planétaire, frein d'arrêt commandé par ressort. Orientation de série commutable en circuit hydraulique ouvert ou fermé (freinage automatique ou au pied).
Cabine du grutier	Construction en tôle d'acier entièrement zinguée avec peinture par poudrage et cuisson au four, avec glaces de sécurité, appareils de commande et de contrôle, équipement confortable, cabine inclinable vers l'arrière.
Dispositif de sécurité	Contrôleur de charge «LICCON», système test limitation de la course pour le levage, soupape de sûreté contre la rupture de tubes et de tuyaux.
Flèche télescopique	Flèche télescopique en acier à haute résistance à grains fins, à profil ovale, 1 élément de base et 5 éléments télescopiques. Tous les éléments télescopiques indépendamment les uns des autres. Système de télescopage séquentiel rapide «Telematik». Longueur de flèche: 36 ft – 164 ft.
Contrepoids	Contrepoids principal de 14800 lbs.
Installation électrique	Technique moderne de transmission de données par BUS de données. Courant continu 24 Volts, 2 batteries de 170 Ah chacune.

Équipement supplémentaire

Fléchette pliante	Longueur: 34 ft – 62 ft, montable sous un angle de 0°, 20° ou 40°. Vérin hydraulique pour le relevage de la fléchette pliante de 0° à 40° (en option).
Rallonge flèche télescopique	Élément en treillis de 23 ft, de cette manière point d'articulation plus haute de 23 ft pour la flèche pliante.
2ème mécanisme de levage	Pour l'utilisation du deuxième crochet, ou bien pour une utilisation avec fléchette pliante lorsque le câble de levage principal rest mouffé.
Contrepoids supplémentaire	37500 lbs pour un contrepoids total de 46300 lbs.
Pneumatiques	8 pneus. Taille: 20.5 R 25.
Entraînement 8 x 8	Essieu 1 est entraîné additionnellement.

Autres équipements supplémentaires sur demande.

Remarks referring to load charts

1. The tabulated lifting capacities do not exceed 85% of the tipping load.
2. The crane's structural steelwork is in accordance with DIN 15018, part 3. Design and construction of the crane comply with DIN 15018, part 2, and with F. E. M. regulations.
3. The 85% overturning limit values take into account wind force 5 = wind speed 20 mph.
4. Lifting capacities are given in kips.
5. The weight of the hook blocks and hooks must be deducted from the lifting capacities.
6. Working radii are measured from the slewing centreline.
7. The lifting capacities given for the telescopic boom only apply if the folding jib is taken off.
8. Subject to modification of lifting capacities.
9. Lifting capacities above 139 kips / 176.3 kips only with additional pulley block / special equipment.

Remarques relatives aux tableaux des charges

1. Les forces de levage indiquées ne dépassent pas 85% de la charge de basculement.
2. La norme DIN 15018, 3ème partie est appliquée pour les charpentes. La construction de la grue est réalisée conformément à la norme DIN 15018, 2ème partie, et aux règles de la F. E. M.
3. A 85% de la charge de basculement, il a été tenu compte d'un vent de force 5 = vitesse de vent 20 mph.
4. Les forces de levage sont données en kips.
5. Les poids des moufles et crochets doit être soustrait des charges indiquées.
6. Les portées sont calculées à partir de l'axe de rotation.
7. Les forces indiquées pour la flèche télescopique s'entendent fléchette dépliée.
8. Charges données sous réserve de modification.
9. Forces de levage plus de 139 kips / 176,3 kips seulement avec un moufle complémentaire / équipement supplémentaire.