



Worldwide offices

International

TADANO Ltd.

International Division
4-12, Kamezawa 2-chome
Sumida-Ku, Tokyo 130-0014, Japan
Phone: +81-3-3621-7750
Fax: +81-3-3621-7785
E-mail: tdnihq@tadano.co.jp

TADANO FAUN GmbH

Faunberg 2
91207 Lauf a. d. Pegnitz
Germany
Phone: +49-9123-955-0
Fax: +49-9123-3085
E-mail: info@tadanofaun.de

TADANO MANTIS Corporation

1705 Columbia Avenue, Suite 200
Franklin, Tennessee USA 37065
Phone: +1-800-272-3325
Fax: +1-615-790-6803
E-mail: sales@mantisranes.com

TADANO Ltd. Middle East Representative Office

P.O.Box 18302, LOB15-323
Jebel Ali Free Zone, Dubai, UAE
Phone: +971-4-887-1353
Fax: +971-4-887-1703
E-mail: tadano@tadano.ae

TADANO Ltd. Beijing Office

Jing Guang Centre, Room 2905
Hu Jia Lou, Chao Yang Qu
Beijing, China
Phone: +86-10-6597-3210
Fax: +86-10-6597-3220
E-mail: beijing@tadano.co.jp

North America

TADANO America Corporation

4242 West Greens Road
Houston, TX 77066, USA
Phone: +1-281-869-0030
Fax: +1-281-869-0040
E-mail: sales@tadano-cranes.com

TADANO South China Co. Ltd.

Room 1803, 18/F Seaview Commercial
Building 21-24 Connaught Road West
Hong Kong
Phone: +852-2544-9310
Fax: +852-2541-5828
E-mail: hiwa@tadanosc.com

TADANO Korea Co. Ltd.

Dangok Bldg 2F, #642-7, Bokjeong-dong
Sujeong-gu, Seongnam-si, Gyeonggi-do
461-830, Korea
Phone: +82-2-714-1600
Fax: +82-2-3274-1304
E-mail: tadano@korea.com

TADANO Asia Pte Ltd.

11 Tuas View Crescent
Multico Building
Singapore 637643
Phone: +65-6863-6901
Fax: +65-6863-6902
E-mail: Tdn-crane@tadanoasia.com

Taiwan TADANO Ltd.

16F, No. 39, Sec. 2 Twng-Hwa S. Rd.
Taipei
Taiwan
Phone: +886-2-2754-0252
Fax: +886-2-2709-2086
E-mail: tadano@ms18.hinet.net

TADANO MANTIS Corporation

1705 Columbia Avenue, Suite 200
Franklin, Tennessee USA 37065
Phone: +1-800-272-3325
Fax: +1-615-790-6803
E-mail: sales@mantisranes.com

ALL-TERRAIN ATF 130G-5

Lift Adjuster



For detailed information about our International Distributor and Service Network, please refer to our homepages.
www.tadano.co.jp + www.tadanoamerica.com + www.mantisranes.com + www.tadanofaun.de

Publisher:

TADANO FAUN GmbH
P.O.Box 10 02 64
91205 Lauf
Germany



01/IV 11/e,sp/DS





ATF 130G-5

Dimensions (ft, mm) / Dimensiones (ft, mm)

445/95 R 25
(16.00 R 25)

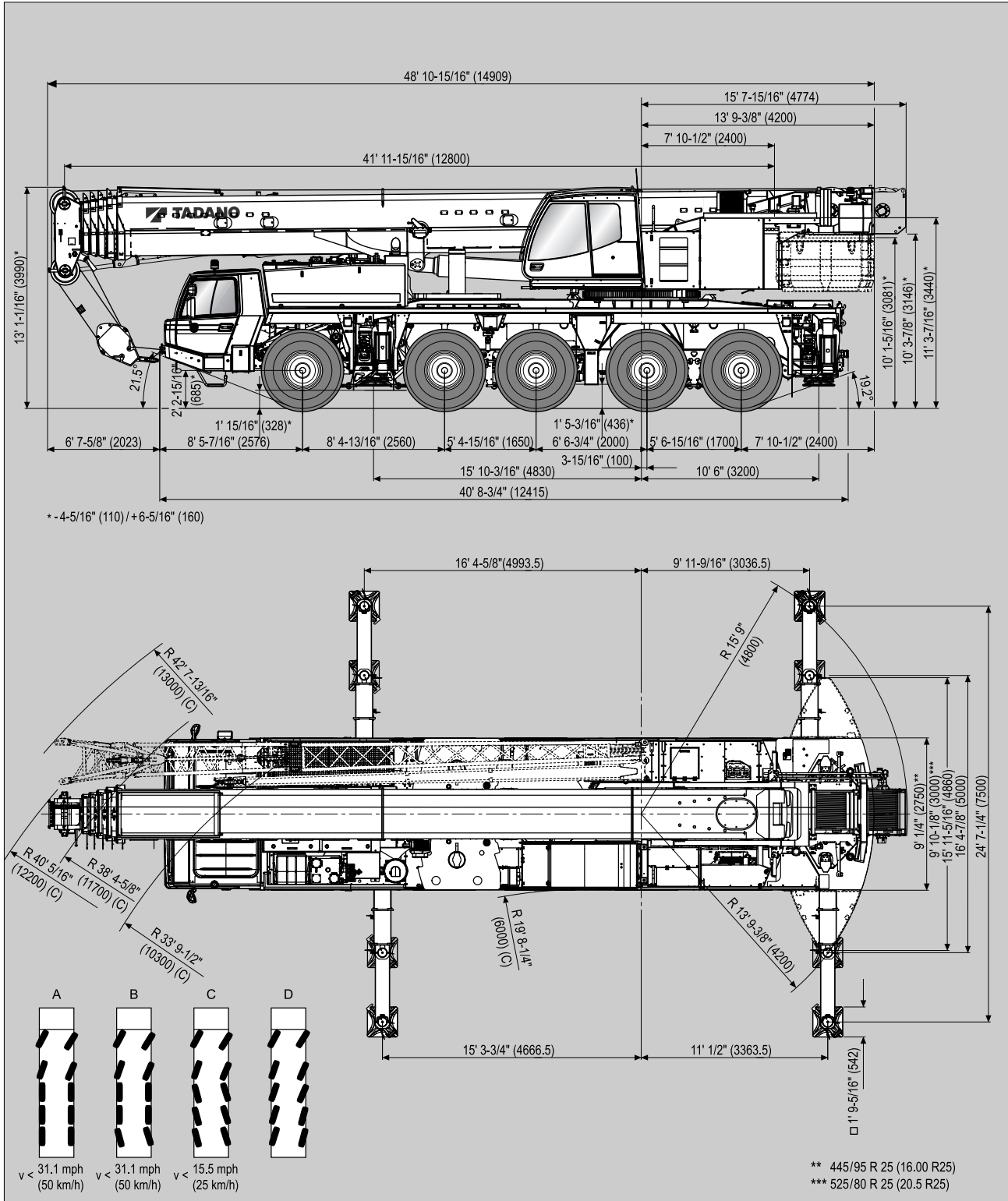



ATF 130G-5

Weights / Working speeds / Pesos / Velocidades de trabajo

	Axle Eje	1	2	3	4	5	Total weight Peso total
	(t)	12	12	12	12	12	60*

* Incl. 6 t counterweight, 3.8 m / 10.2 m / 18.0 m boom extension, 63 t hook block, 10 t swivel hook, drive 10 x 8, tyres 445/95 R 25 (16.00 R 25).

* Incl. contrapeso de 6 t, 3,8 m / 10,2 m / 18,0 m plumin, 63 t gancho, 10 t gancho de bola, tracción 10 x 8, neumáticos 445/95 R 25 (16.00 R 25).

	Lifting capacity Capacidad de elevación	Sheaves Poleas	Parts of line Ramales de cable	Weight Peso
	125 t*	7	15	2,645.5 lbs
	80 t*	5	11	1,763.7 lbs
	63 t*	3	7	1,322.8 lbs
	63 t	3	7	1,322.8 lbs
	25 t	1	3	826.7 lbs
	10 t	-	1	661.4 lbs

* Rams horn
* Gancho doble



		1	2	3	4	5	6	7	8	9	10	11	12	R1	R2	
445/95 (16.00) km/h		1.9	1.9	2.5	3.7	4.3	5.6	7.5	9.3	12.4	15.5	19.9	25.5	1.9	2.5	
		3.7	5.0	6.2	8.1	9.9	13.0	16.8	21.7	28.0	36.0	46.0	52.8	3.7	5.0	52%

* Off road range / * Con transmisión todo terreno

V+	Infinitely variable Infinitamente variable	Rope Cable	Max. single line pull Trio máximo por ramal
	0 - 426.5 ft/min 0 - 130 m/min	single line ramal simple	0,83' / 820.2' 21 mm / 250 m
	0 - 249.3 ft/min 0 - 76 m/min	single line ramal simple	0,83' / 820.2' 21 mm / 250 m
	0 - 1.6 min ⁻¹		
	-1.0° - +82.7°	approx. 42 s aproximadamente 42 s	
	41' 11-15/16" - 196' 10-3/16" 12.8 m - 60.0 m	approx. 380 s aproximadamente 380 s	

Subject to change without prior notice / Sujeto a cambios sin previo aviso



ATF 130G-5

Lifting capacities / Capacidades de elevación

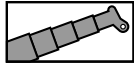

92,593 lbs

SAE

ft	42.0 ft*	42.0 ft	56.2 ft	70.3 ft	84.5 ft	98.7 ft	112.9 ft	127.0 ft	141.2 ft	155.4 ft	169.6 ft	183.7 ft	196.8 ft
8.0	320.0**												
8.9	286.6**												
9.8	245.2**	230.8**	198.4	198.4									
11.5	219.8	211.0	198.4	198.4	154.3								
13.1	201.5	194.2	194.0	193.1	154.3								
14.8	183.6	179.7	179.5	178.6	154.3	119.7							
16.4	167.1	167.1	166.9	166.0	154.3	113.1	97.0						
19.7	146.2	145.9	145.7	144.6	145.5	110.2	93.3	72.3					
23.0	129.6	128.1	128.5	126.8	128.1	108.7	84.7	72.3	59.7				
26.2	116.2	112.9	113.8	113.3	112.7	101.4	83.8	72.3	59.7	47.2			
29.5	105.2	100.1	101.0	101.0	99.9	95.0	78.9	66.8	59.7	47.2	36.6		
32.8	92.8	89.5	90.4	90.4	89.3	89.5	74.3	61.9	58.4	47.2	36.6	29.1	
36.1			81.6	81.6	80.5	82.0	70.1	57.8	54.5	47.2	36.6	29.1	23.4
39.4			74.1	74.1	73.9	74.5	66.4	54.0	50.9	47.0	36.6	29.1	23.4
45.9			62.2	61.9	63.3	62.4	60.0	47.6	45.0	42.3	36.6	29.1	23.4
52.5				50.5	51.8	50.9	52.7	42.5	40.1	38.4	34.8	29.1	23.4
59.1				43.7	43.4	45.4	44.1	38.4	36.8	34.6	32.0	28.2	23.4
65.6					38.4	38.8	37.5	34.8	33.5	31.1	29.8	26.5	23.1
72.2					35.3	34.4	33.1	31.1	30.6	28.0	26.9	24.7	21.4
78.7						30.6	29.3	28.4	28.0	25.4	24.3	22.9	19.8
85.3						27.3	26.0	26.2	25.4	23.1	22.0	21.6	18.1
91.9							23.4	24.0	22.9	21.2	20.3	19.8	16.5
98.4							22.3	21.6	20.5	19.2	18.5	18.3	15.2
105.0								19.4	18.5	17.4	17.2	16.8	13.9
111.5								17.6	16.8	16.3	15.9	15.7	12.8
118.1									15.7	15.0	14.6	14.6	11.9
124.7									14.6	13.7	13.4	13.4	11.0
131.2									13.7	12.6	12.6	12.3	10.1
137.8										11.5	11.7	11.0	9.5
144.4										10.4	10.8	9.9	8.8
150.9											9.9	9.0	8.4
157.5											9.0	8.2	7.7
164.0												7.3	7.1
170.6												6.6	6.4
177.2													5.7
183.7													5.3

* Over rear / * Sobre la parte trasera / ** With additional lifting equipment / ** Con equipo adicional

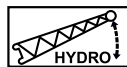
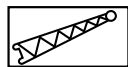
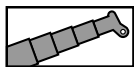

92,593 lbs

SAE

ft	196.8 ft + 12.5 ft			196.8 ft + 33.5 ft			196.8 ft + 59.1 ft			196.8 ft + 82.0 ft			196.8 ft + 105.0 ft		
	0°	20°	40°	0°	20°	40°	0°	20°	40°	0°	20°	40°	0°	20°	40°
39.4				12.6											
45.9	17.2	17.2	17.2	12.6			7.9								
52.5	17.2	16.8	16.3	12.6	12.6		7.9			6.0					
59.1	16.5	15.9	15.4	12.6	12.3		7.9			6.0			4.4		
65.6	15.7	15.2	14.8	12.6	11.9	11.0	7.9			6.0			4.4		
72.2	14.8	14.3	14.1	12.6	11.2	10.6	7.9	7.3		6.0			4.4		
78.7	14.1	13.7	13.4	11.9	10.8	10.1	7.9	7.1		6.0			4.4		
85.3	13.4	13.0	13.0	11.5	10.4	9.9	7.9	6.8	5.7	6.0	6.0		4.4		
91.9	12.8	12.6	12.3	11.0	9.9	9.5	7.9	6.6	5.5	6.0	6.0		4.4		
98.4	12.1	11.9	11.7	10.4	9.7	9.3	7.9	6.4	5.3	6.0	5.7		4.4	4.2	
105.0	11.5	11.2	11.2	9.9	9.3	8.8	7.9	6.2	5.3	6.0	5.5	5.1	4.4	4.2	
111.5	11.0	10.8	10.8	9.7	9.0	8.6	7.5	6.0	5.1	6.0	5.3	5.1	4.4	4.0	
118.1	10.4	10.4	10.1	9.3	8.8	8.4	7.3	6.0	5.1	5.7	5.1	4.9	4.4	4.0	
124.7	9.9	9.9	9.9	8.8	8.4	8.2	7.1	5.7	4.9	5.5	5.1	4.6	4.4	4.0	3.5
131.2	9.7	9.5	9.5	8.6	8.2	7.9	6.8	5.7	4.9	5.3	4.9	4.4	4.2	3.7	3.5
144.4	8.2	8.4	8.4	7.9	7.5	7.3	6.4	5.3	4.6	5.1	4.4	4.2	4.0	3.5	3.3
157.5	6.8	7.1		6.8	6.6	6.6	5.7	5.1	4.6	4.6	4.2	4.0	3.7	3.3	3.1
170.6	5.3	5.3		5.5	6.0	6.0	5.1	4.9	4.6	4.2	3.7	3.7	3.5	3.1	2.9
183.7	4.0	4.0		4.2	4.9		4.6	4.4	4.4	3.7	3.5	3.3	3.1	2.9	2.6
196.8	2.9			3.1	3.5		3.7	4.0	4.0	3.3	3.1	3.1	2.9	2.6	2.4
210.0				2.2	2.4		2.6	3.3		2.9	2.9	2.9	2.4	2.4	2.2
223.1								2.2		2.0	2.6	2.6	2.2	2.0	2.2
236.2															2.0



ATF 130G-5

Lifting heights / Alturas de elevación

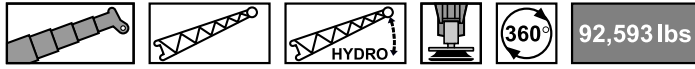

SAE

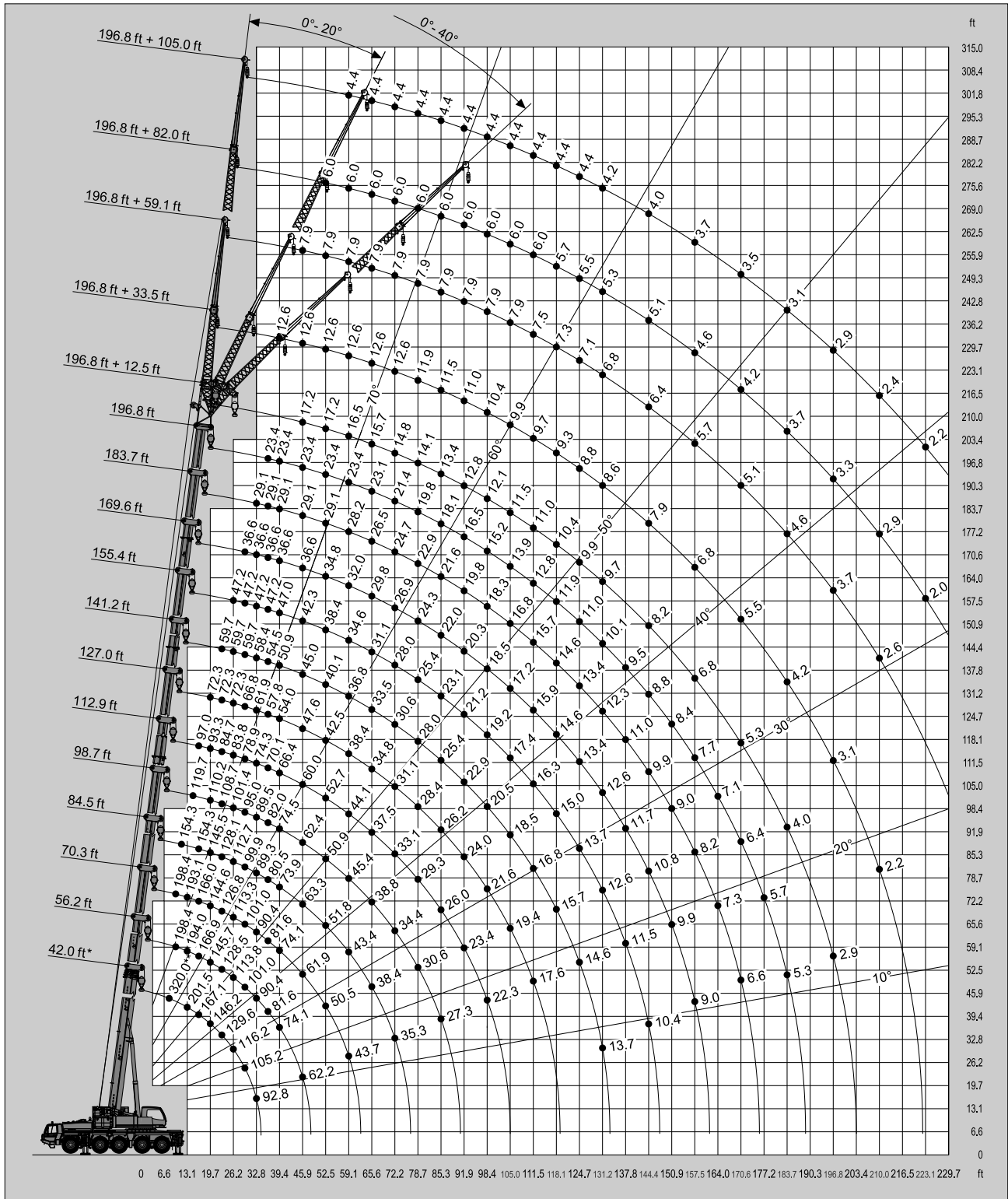

* Over rear / * Sobre la parte trasera
** With additional lifting equipment / ** Con equipo adicional



ATF 130G-5

Lifting capacities / Capacidades de elevación

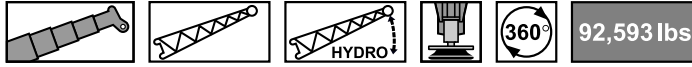

SAE

ft	183.7 ft + 12.5 ft			183.7 ft + 33.5 ft			183.7 ft + 59.1 ft			183.7 ft + 82.0 ft			183.7 ft + 105.0 ft		
	0°	20°	40°	0°	20°	40°	0°	20°	40°	0°	20°	40°	0°	20°	40°
39.4	19.8	19.8		14.1			8.6			6.4					
45.9	19.8	19.4	18.7	14.1			8.6			6.4				4.6	
52.5	19.2	18.3	17.9	14.1	14.1		8.6			6.4				4.6	
59.1	18.1	17.4	17.0	14.1	13.4	12.6	8.6			6.4				4.6	
65.6	17.0	16.5	16.1	14.1	12.8	11.9	8.6	7.7		6.4				4.6	
72.2	16.1	15.7	15.4	13.7	12.1	11.5	8.6	7.5		6.4				4.6	
78.7	15.2	15.0	14.8	13.0	11.7	11.0	8.6	7.3	6.0	6.4	6.4			4.6	
85.3	14.3	14.1	13.9	12.3	11.2	10.6	8.6	7.1	5.7	6.4	6.4			4.6	
91.9	13.7	13.4	13.2	11.9	10.8	10.1	8.6	6.6	5.5	6.4	6.4			4.6	
98.4	13.0	12.8	12.6	11.5	10.4	9.9	8.6	6.6	5.5	6.4	6.2	5.5		4.6	4.4
105.0	12.3	12.1	11.9	10.8	10.1	9.5	8.4	6.4	5.3	6.4	6.0	5.3		4.6	4.4
111.5	11.7	11.5	11.5	10.4	9.7	9.3	8.2	6.2	5.3	6.4	5.7	5.3		4.6	4.2
118.1	11.2	11.0	11.0	10.1	9.5	9.0	7.9	6.0	5.1	6.2	5.5	5.1		4.6	4.2
124.7	10.8	10.6	10.6	9.7	9.0	8.8	7.5	5.7	5.1	6.0	5.3	4.9		4.6	4.0
131.2	10.4	10.1	10.1	9.3	8.8	8.6	7.3	5.7	5.1	5.7	5.1	4.9		4.6	4.0
144.4	8.8	8.8	9.0	8.4	8.4	8.2	6.8	5.5	4.9	5.5	4.9	4.4		4.4	3.7
157.5	6.8	7.1		7.3	7.7	7.7	6.6	5.3	4.6	5.1	4.4	4.2		4.0	3.5
170.6	5.3	5.3		5.7	6.2		6.2	5.1	4.6	4.9	4.2	4.0		3.7	3.3
183.7	4.0			4.4	4.9		5.1	5.1	4.6	4.4	4.0	3.7		3.5	3.1
196.8				3.3	3.5		4.0	4.4		4.2	3.7	3.5		3.3	2.9
210.0							2.9	3.3		3.1	3.7	3.5		3.1	2.6
223.1							2.0	2.2		2.2	2.9			2.6	2.4
236.2											2.0			2.4	2.2

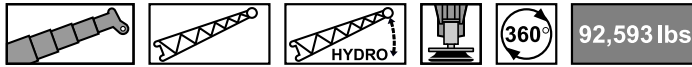



SAE

ft	141.2 ft + 12.5 ft			141.2 ft + 33.5 ft			141.2 ft + 59.1 ft			141.2 ft + 82.0 ft			141.2 ft + 105.0 ft		
	0°	20°	40°	0°	20°	40°	0°	20°	40°	0°	20°	40°	0°	20°	40°
26.2				23.4											
29.5	36.6	33.1	31.1	23.4											
32.8	34.8	31.7	30.0	23.4			12.1								
36.1	33.5	30.6	28.9	23.4			12.1								
39.4	32.2	29.5	28.0	23.4	22.3		12.1				8.4				
45.9	29.8	27.6	26.2	23.4	20.7	18.1	12.1				8.4			6.0	
52.5	27.8	26.0	24.9	23.1	19.6	17.0	12.1	9.0			8.4			6.0	
59.1	26.2	24.5	23.6	21.8	18.3	16.3	11.9	8.6			8.4			6.0	
65.6	24.9	23.4	22.7	20.5	17.4	15.7	11.5	8.2	6.6		8.4	7.9		6.0	
72.2	23.6	22.3	21.6	19.4	16.5	15.0	10.8	7.9	6.4		8.4	7.7		6.0	
78.7	22.0	21.4	20.9	18.3	15.9	14.3	10.4	7.5	6.2		8.4	7.5		6.0	5.7
85.3	20.5	20.3	20.3	17.4	15.2	13.9	9.9	7.3	6.0		8.4	7.3	6.0	6.0	5.5
91.9	19.2	19.0	19.2	16.5	14.6	13.4	9.5	7.1	6.0		8.2	7.1	5.7	6.0	5.3
98.4	17.9	17.9	17.9	15.9	14.1	13.0	9.0	6.8	5.7		8.2	6.8	5.5	6.0	5.1
105.0	16.1	16.3	16.5	15.2	13.7	12.6	8.6	6.6	5.7		7.9	6.6	5.3	6.0	5.1
111.5	14.3	14.6	14.8	14.8	13.2	12.3	8.4	6.4	5.5		7.7	6.4	5.3	6.0	4.9
118.1	12.6	12.8		13.4	12.8	12.1	7.9	6.2	5.5		7.5	6.2	5.1	5.7	4.6
124.7	11.0	11.2		11.9	12.6	11.7	7.7	6.0	5.3		7.3	6.0	4.9	5.5	4.6
131.2	9.7	9.9		10.6	11.2	11.7	7.5	6.0	5.3		7.1	5.7	4.9	5.3	4.4
144.4	7.5			8.4	8.8		7.1	5.7	5.3		6.4	5.5	4.6	4.9	4.0
157.5				6.6	6.8		6.6	5.5	5.3		5.7	5.1	4.4	4.2	3.7
170.6							6.2	5.5			5.1	4.9	4.4	3.7	3.5
183.7							4.9				4.6	4.6		3.3	3.3
196.8											4.0	4.4		2.9	3.1
210.0											3.1			2.6	2.9
223.1														2.4	2.9

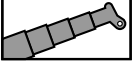
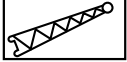

ATF 130G-5

Lifting heights / Alturas de elevación

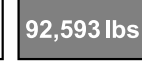
SAE



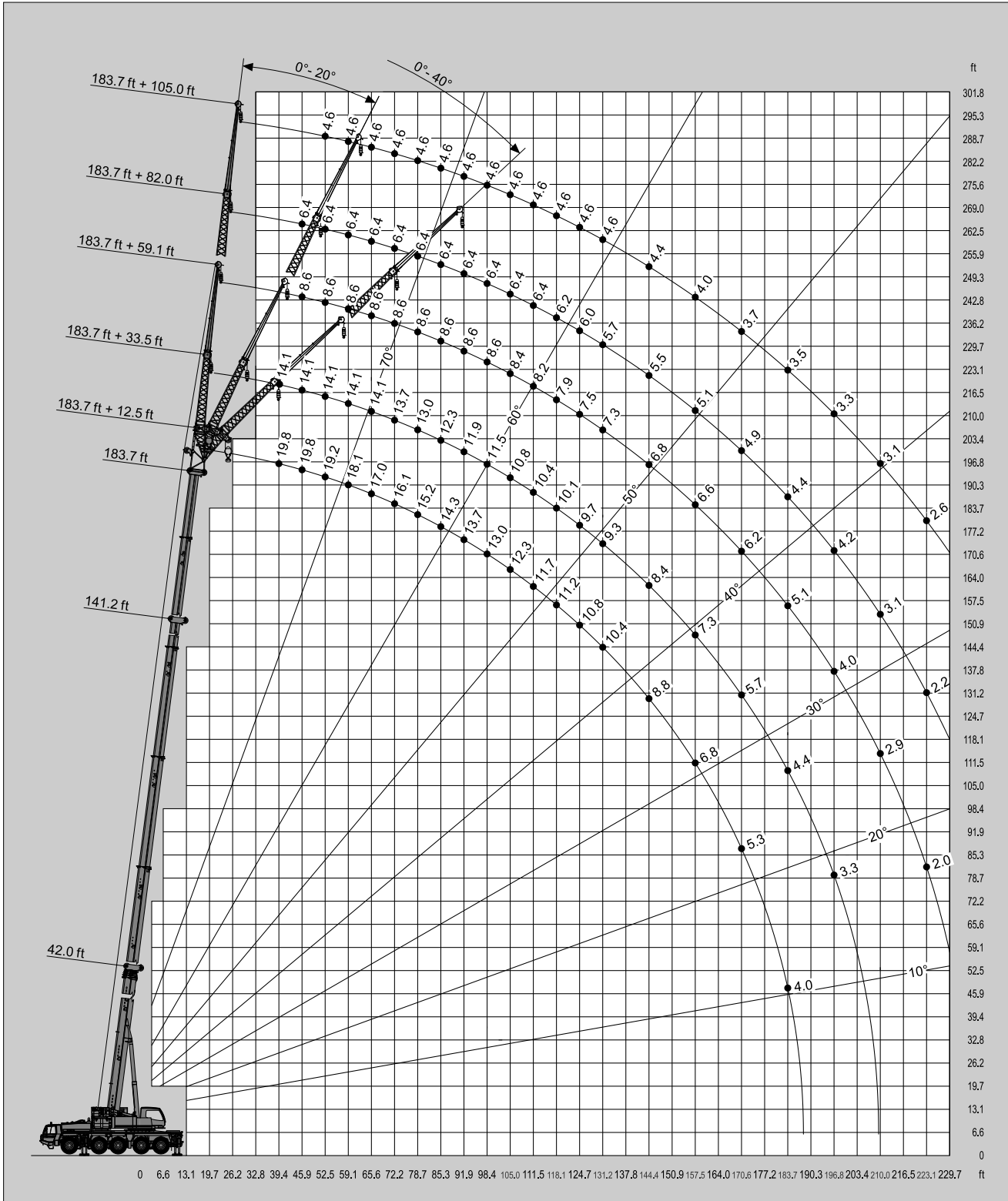

ATF 130G-5

Lifting capacities / Capacidades de elevación

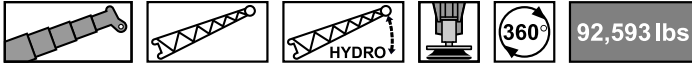

SAE

ft	42.0 ft + 12.5 ft			42.0 ft + 33.5 ft			42.0 ft + 59.1 ft			42.0 ft + 82.0 ft			42.0 ft + 105.0 ft		
	0°	20°	40°	0°	20°	40°	0°	20°	40°	0°	20°	40°	0°	20°	40°
9.8	88.2	72.1		33.1			17.2								
11.5	88.2	69.0	55.6	33.1			17.2								
13.1	88.2	66.1	54.0	33.1			17.2								
14.8	85.8	63.7	52.5	33.1			17.2			11.2					
16.4	81.1	61.3	51.1	33.1	31.1		17.2			11.2					
19.7	73.4	57.3	48.9	33.1	28.7		17.2			11.2			7.7		
23.0	67.0	53.8	47.0	33.1	26.7		16.5			11.2			7.7		
26.2	61.7	50.9	45.2	33.1	24.9	20.1	15.7			11.2			7.7		
29.5	57.3	48.5	43.9	30.4	23.4	19.2	14.8	11.5		11.2			7.7		
32.8	53.6	46.3	43.0	27.8	22.0	18.5	13.9	11.0		11.2			7.7		
36.1	50.5	44.5	42.3	25.1	20.7	17.6	13.2	10.4		11.2			7.7		
39.4	47.6	43.2		22.9	19.8	17.2	12.6	9.9		11.2			7.7		
45.9	44.1			19.6	18.1	16.1	11.2	9.0	7.7	10.8	9.9		7.7		
52.5				17.2	16.8	15.4	10.1	8.4	7.3	10.4	8.8		7.7		
59.1				15.2	15.7		9.3	7.7	6.8	9.7	7.9		7.7	6.8	
65.6				13.4			8.6	7.3	6.6	8.4	7.3	6.2	7.1	6.2	
72.2							7.9	6.8	6.4	7.5	6.6	5.7	6.2	5.7	
78.7							7.3	6.6	6.2	6.6	6.2	5.5	5.5	5.1	
85.3							6.8	6.4		6.0	5.7	5.1	4.9	4.9	4.2
91.9							6.6			5.3	5.3	4.9	4.4	4.4	4.0
98.4										4.9	5.1	4.6	4.0	4.2	3.5
105.0										4.4	4.6		3.5	3.7	3.5
111.5										4.0			3.1	3.5	3.3
118.1													2.9	3.3	3.1
124.7													2.6	3.1	3.1
131.2													2.4	3.1	

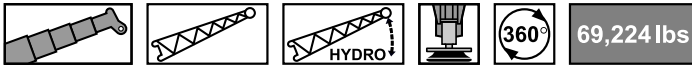



SAE

ft	42.0 ft + 12.5 ft			42.0 ft + 33.5 ft			42.0 ft + 59.1 ft			42.0 ft + 82.0 ft			42.0 ft + 105.0 ft		
	0°	20°	40°	0°	20°	40°	0°	20°	40°	0°	20°	40°	0°	20°	40°
9.8	88.2	72.1		33.1			17.2								
11.5	88.2	69.0	55.6	33.1			17.2								
13.1	88.2	66.1	54.0	33.1			17.2								
14.8	85.8	63.7	52.5	33.1			17.2			11.2					
16.4	81.1	61.3	51.1	33.1	31.1		17.2			11.2					
19.7	73.4	57.3	48.9	33.1	28.7		17.2			11.2			7.7		
23.0	67.0	53.8	47.0	33.1	26.7		16.5			11.2			7.7		
26.2	61.7	50.9	45.2	33.1	24.9	20.1	15.7			11.2			7.7		
29.5	57.3	48.5	43.9	30.4	23.4	19.2	14.8	11.5		11.2			7.7		
32.8	53.6	46.3	43.0	27.8	22.0	18.5	13.9	11.0		11.2			7.7		
36.1	50.5	44.5	42.3	25.1	20.7	17.6	13.2	10.4		11.2			7.7		
39.4	47.6	43.2		22.9	19.8	17.2	12.6	9.9		11.2			7.7		
45.9	44.1			19.6	18.1	16.1	11.2	9.0	7.7	10.8	9.9		7.7		
52.5				17.2	16.8	15.4	10.1	8.4	7.3	10.4	8.8		7.7		
59.1				15.2	15.7		9.3	7.7	6.8	9.7	7.9		7.7	6.8	
65.6				13.4			8.6	7.3	6.6	8.4	7.3	6.2	7.1	6.2	
72.2							7.9	6.8	6.4	7.5	6.6	5.7	6.2	5.7	
78.7							7.3	6.6	6.2	6.6	6.2	5.5	5.5	5.1	
85.3							6.8	6.4		6.0	5.7	5.1	4.9	4.9	4.2
91.9							6.6			5.3	5.3	4.9	4.4	4.4	4.0
98.4										4.9	5.1	4.6	4.0	4.2	3.5
105.0										4.4	4.6		3.5	3.7	3.5
111.5										4.0			3.1	3.5	3.3
118.1													2.9	3.3	3.1
124.7													2.6	3.1	3.1
131.2													2.4	3.1	

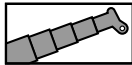
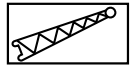
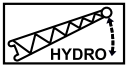

ATF 130G-5

Lifting heights / Alturas de elevación



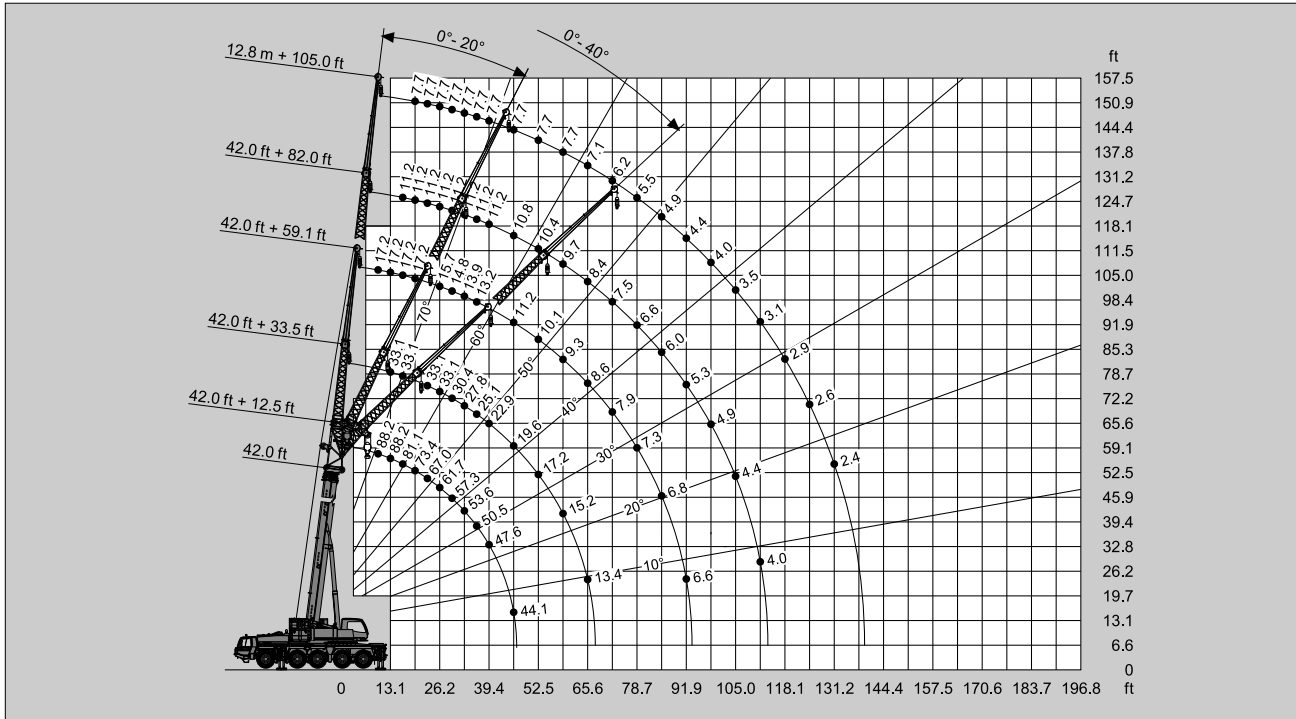

92,593 lbs

SAE

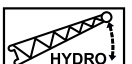





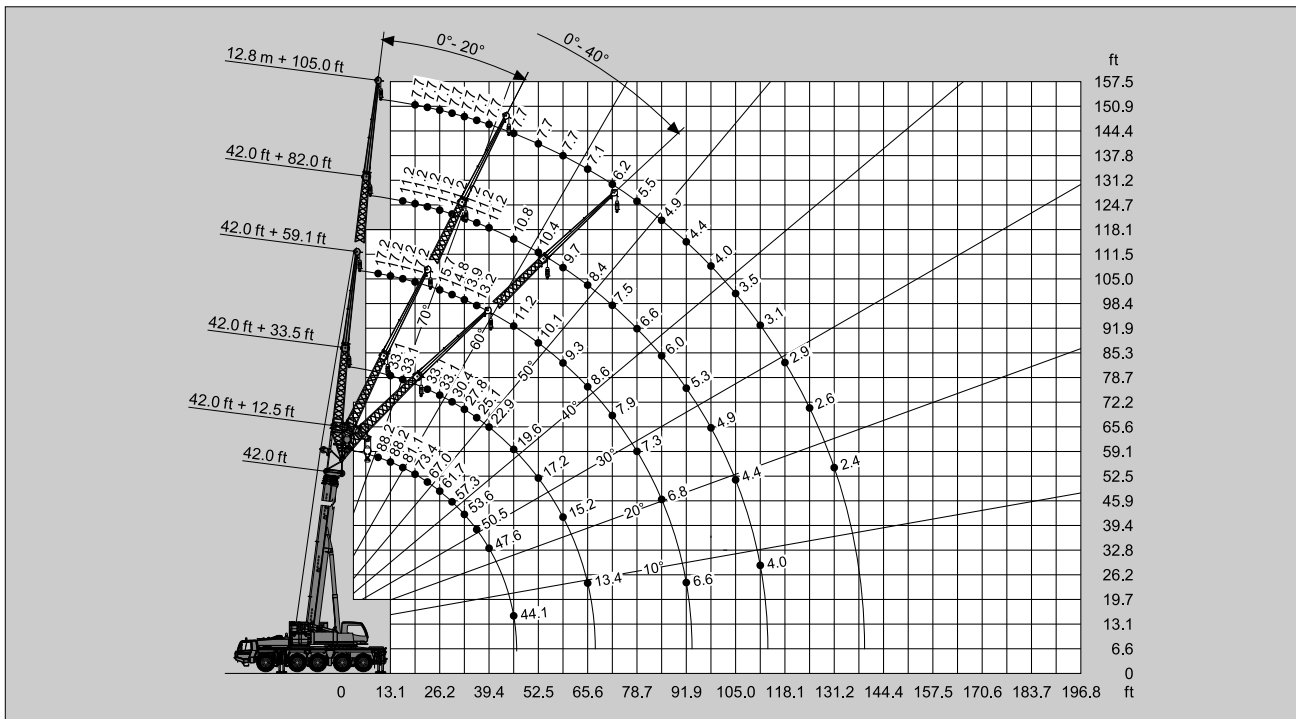

69,224 lbs

SAE





ATF 130G-5

Lifting capacities / Capacidades de elevación

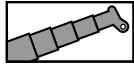

69,224 lbs

SAE

ft	42.0 ft*	42.0 ft	56.2 ft	70.3 ft	84.5 ft	98.7 ft	112.9 ft	127.0 ft	141.2 ft	155.4 ft	169.6 ft	183.7 ft	196.8 ft
8.9	286.6**												
9.8	238.8**	228.8**	198.4	198.4									
11.5	216.3	209.0	198.4	198.4	154.3								
13.1	196.7	192.5	192.2	191.4	154.3								
14.8	180.8	178.1	177.7	177.0	154.3	119.7							
16.4	165.6	165.1	164.9	163.8	154.3	113.1	97.0						
19.7	144.8	142.2	142.0	140.7	142.2	110.2	93.3	72.3					
23.0	128.5	122.8	123.5	123.0	122.6	108.7	84.7	72.3	59.7				
26.2	115.1	107.4	108.0	108.2	107.1	101.4	83.8	72.3	59.7	47.2			
29.5	103.4	95.0	95.7	95.9	94.6	95.0	78.9	66.8	59.7	47.2	36.6		
32.8	86.9	84.9	85.3	85.5	84.4	86.0	74.3	61.9	58.4	47.2	36.6	29.1	
36.1			75.2	75.2	76.7	75.8	70.1	57.8	54.5	47.2	36.6	29.1	23.4
39.4			65.3	65.5	67.0	65.9	66.4	54.0	50.9	47.0	36.6	29.1	23.4
45.9			54.7	51.1	52.5	54.9	53.6	47.6	45.0	42.3	36.6	29.1	23.4
52.5				43.9	45.2	44.8	43.4	42.1	40.1	38.4	34.8	29.1	23.4
59.1				39.7	37.9	37.5	36.2	35.1	36.2	34.6	32.0	28.2	23.4
65.6					33.3	31.7	31.7	32.0	30.6	30.0	29.8	26.5	23.1
72.2					29.3	28.2	27.8	27.3	26.2	26.0	26.2	24.7	21.4
78.7						25.1	25.4	23.8	23.4	23.4	23.4	22.9	19.8
85.3						22.5	22.7	21.6	21.6	21.2	20.7	20.9	18.1
91.9							20.5	19.2	19.8	19.0	19.0	18.7	16.5
98.4							18.3	17.2	18.1	16.8	17.4	16.5	15.2
105.0								15.4	16.3	15.0	15.7	14.6	13.9
111.5								13.9	14.6	13.7	13.9	13.0	12.6
118.1									12.8	12.6	12.3	11.5	11.2
124.7									11.9	11.5	11.0	10.1	9.9
131.2									11.2	10.6	9.9	8.8	8.8
137.8										9.7	8.8	7.7	7.7
144.4										8.8	7.7	6.8	6.6
150.9											7.1	6.0	5.7
157.5											6.4	5.1	5.1
164.0												4.4	4.4
170.6												3.7	3.7
177.2													3.1
183.7													2.4

* Over rear / * Sobre la parte trasera / ** With additional lifting equipment / ** Con equipo adicional

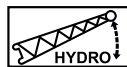
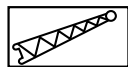
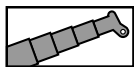

69,224 lbs

SAE

ft	196.8 ft + 12.5 ft			196.8 ft + 33.5 ft			196.8 ft + 59.1 ft			196.8 ft + 82.0 ft			196.8 ft + 105.0 ft		
	0°	20°	40°	0°	20°	40°	0°	20°	40°	0°	20°	40°	0°	20°	40°
39.4				12.6											
45.9	17.2	17.2	17.2	12.6			7.9								
52.5	17.2	16.8	16.3	12.6	12.6		7.9			6.0					
59.1	16.5	15.9	15.4	12.6	12.3		7.9			6.0			4.4		
65.6	15.7	15.2	14.8	12.6	11.9	11.0	7.9			6.0			4.4		
72.2	14.8	14.3	14.1	12.6	11.2	10.6	7.9	7.3		6.0			4.4		
78.7	14.1	13.7	13.4	11.9	10.8	10.1	7.9	7.1		6.0			4.4		
85.3	13.4	13.0	13.0	11.5	10.4	9.9	7.9	6.8	5.7	6.0	6.0		4.4		
91.9	12.8	12.6	12.3	11.0	9.9	9.5	7.9	6.6	5.5	6.0	6.0		4.4		
98.4	12.1	11.9	11.7	10.4	9.7	9.3	7.9	6.4	5.3	6.0	5.7		4.4	4.2	
105.0	11.5	11.2	11.2	9.9	9.3	8.8	7.9	6.2	5.3	6.0	5.5	5.1	4.4	4.2	
111.5	11.0	10.8	10.8	9.7	9.0	8.6	7.5	6.0	5.1	6.0	5.3	5.1	4.4	4.0	
118.1	9.9	10.1	10.1	9.3	8.8	8.4	7.3	6.0	5.1	5.7	5.1	4.9	4.4	4.0	
124.7	8.6	8.8	9.0	8.8	8.4	8.2	7.1	5.7	4.9	5.5	5.1	4.6	4.4	4.0	3.5
131.2	7.5	7.7	7.7	7.7	8.2	7.9	6.8	5.7	4.9	5.3	4.9	4.4	4.2	3.7	3.5
144.4	5.5	5.7	5.7	5.7	6.6	7.1	6.4	5.3	4.6	5.1	4.4	4.2	4.0	3.5	3.3
157.5	4.0	4.0		4.0	4.9	5.3	4.9	5.1	4.6	4.6	4.2	4.0	3.7	3.3	3.1
170.6	2.4	2.6		2.6	3.5	3.7	3.5	4.4	4.6	3.7	3.7	3.7	3.5	3.1	2.9
183.7					2.2		2.4	3.1	3.5	2.6	3.5	3.3	2.9	2.9	2.6
196.8								2.0	2.4		2.6	3.1	2.6	2.4	2.4
210.0												2.0	2.2	2.2	2.2
223.1															2.0



ATF 130G-5

Lifting heights / Alturas de elevación



SAE

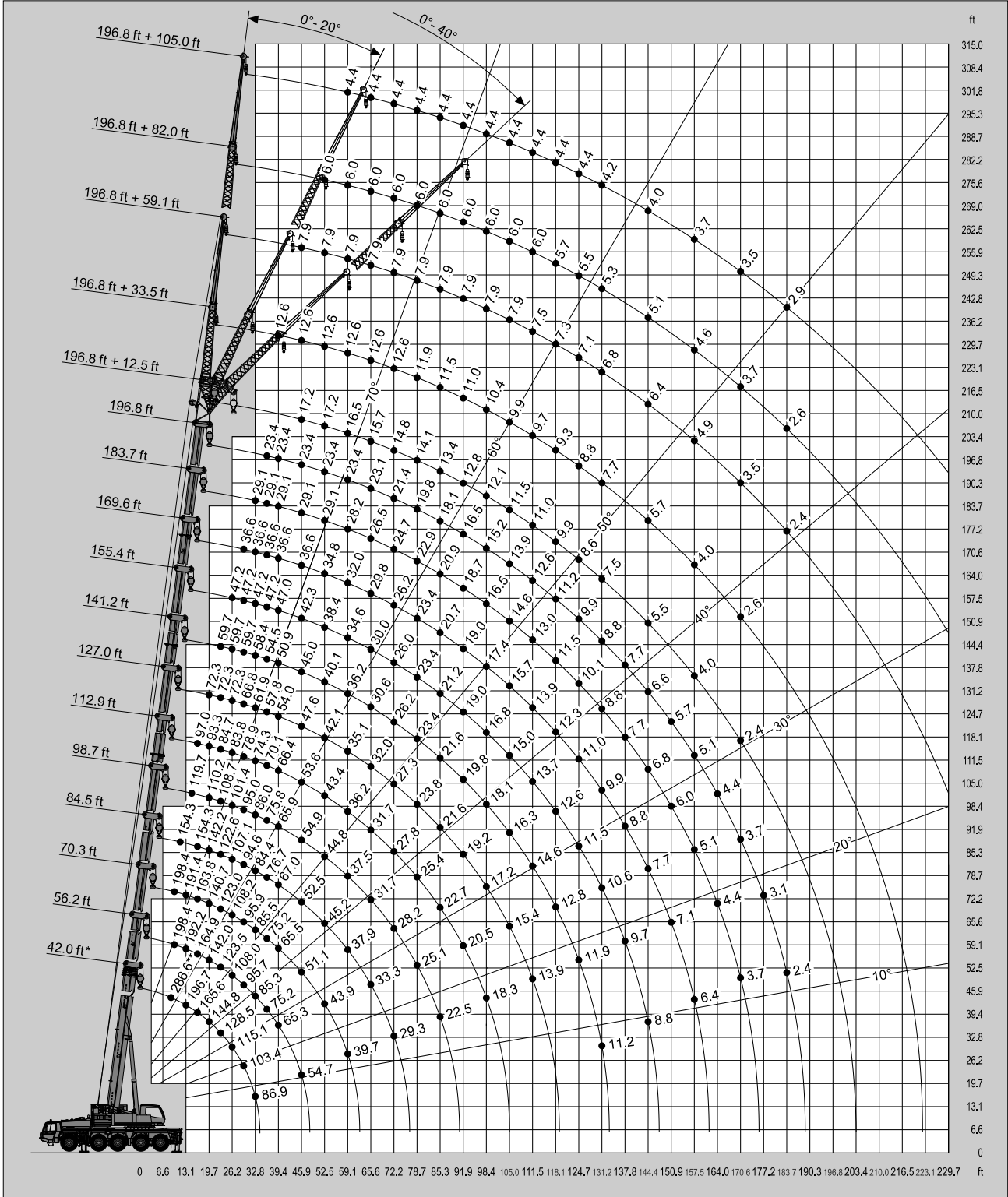

* Over rear / * Sobre la parte trasera
** With additional lifting equipment / ** Con equipo adicional



ATF 130G-5

Lifting capacities / Capacidades de elevación

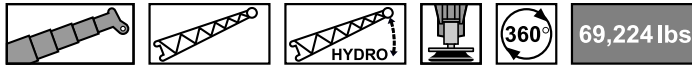

SAE

ft	183.7 ft + 12.5 ft			183.7 ft + 33.5 ft			183.7 ft + 59.1 ft			183.7 ft + 82.0 ft			183.7 ft + 105.0 ft		
	0°	20°	40°	0°	20°	40°	0°	20°	40°	0°	20°	40°	0°	20°	40°
39.4	19.8	19.8		14.1											
45.9	19.8	19.4	18.7	14.1			8.6			6.4					
52.5	19.2	18.3	17.9	14.1	14.1		8.6			6.4			4.6		
59.1	18.1	17.4	17.0	14.1	13.4	12.6	8.6			6.4			4.6		
65.6	17.0	16.5	16.1	14.1	12.8	11.9	8.6	7.7		6.4			4.6		
72.2	16.1	15.7	15.4	13.7	12.1	11.5	8.6	7.5		6.4			4.6		
78.7	15.2	15.0	14.8	13.0	11.7	11.0	8.6	7.3	6.0	6.4	6.4		4.6		
85.3	14.3	14.1	13.9	12.3	11.2	10.6	8.6	7.1	5.7	6.4	6.4		4.6		
91.9	13.7	13.4	13.2	11.9	10.8	10.1	8.6	6.6	5.5	6.4	6.4		4.6		
98.4	13.0	12.8	12.6	11.5	10.4	9.9	8.6	6.6	5.5	6.4	6.2	5.5	4.6	4.4	
105.0	12.3	12.1	11.9	10.8	10.1	9.5	8.4	6.4	5.3	6.4	6.0	5.3	4.6	4.4	
111.5	11.5	11.5	11.5	10.4	9.7	9.3	8.2	6.2	5.3	6.4	5.7	5.3	4.6	4.2	
118.1	9.9	10.1	10.4	10.1	9.5	9.0	7.9	6.0	5.1	6.2	5.5	5.1	4.6	4.2	
124.7	8.6	8.8	9.0	8.8	9.0	8.8	7.5	5.7	5.1	6.0	5.3	4.9	4.6	4.0	3.5
131.2	7.5	7.7	7.7	7.7	8.8	8.6	7.3	5.7	5.1	5.7	5.1	4.9	4.6	4.0	3.5
144.4	5.5	5.7	5.7	5.7	6.6	7.1	6.6	5.5	4.9	5.5	4.9	4.4	4.4	3.7	3.3
157.5	4.0	4.0		4.2	4.9	5.3	5.1	5.3	4.6	5.1	4.4	4.2	4.0	3.5	3.1
170.6	2.6	2.6		2.9	3.5		3.7	4.4	4.6	4.0	4.2	4.0	3.7	3.3	3.1
183.7					2.2		2.6	3.3	3.5	2.9	3.7	3.7	3.1	3.1	2.9
196.8								2.2			2.6	3.3	2.2	2.9	2.6
210.0												2.2		2.2	2.4
223.1															2.0

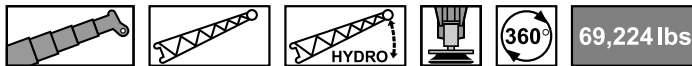

SAE

ft	141.2 ft + 12.5 ft			141.2 ft + 33.5 ft			141.2 ft + 59.1 ft			141.2 ft + 82.0 ft			141.2 ft + 105.0 ft		
	0°	20°	40°	0°	20°	40°	0°	20°	40°	0°	20°	40°	0°	20°	40°
26.2				23.4											
29.5	36.6	33.1	31.1	23.4											
32.8	34.8	31.7	30.0	23.4			12.1								
36.1	33.5	30.6	28.9	23.4			12.1			8.4					
39.4	32.2	29.5	28.0	23.4	22.3		12.1			8.4			6.0		
45.9	29.8	27.6	26.2	23.4	20.7	18.1	12.1			8.4			6.0		
52.5	27.8	26.0	24.9	23.1	19.6	17.0	12.1	9.0		8.4			6.0		
59.1	26.2	24.5	23.6	21.8	18.3	16.3	11.9	8.6		8.4			6.0		
65.6	24.9	23.4	22.7	20.5	17.4	15.7	11.5	8.2	6.6	8.4	7.9		6.0		
72.2	23.6	22.3	21.6	19.4	16.5	15.0	10.8	7.9	6.4	8.4	7.7		6.0		
78.7	21.4	21.4	20.9	18.3	15.9	14.3	10.4	7.5	6.2	8.4	7.5		6.0	5.7	
85.3	18.5	19.0	19.2	17.4	15.2	13.9	9.9	7.3	6.0	8.4	7.3	6.0	6.0	5.5	
91.9	15.9	16.1	16.5	16.5	14.6	13.4	9.5	7.1	6.0	8.2	7.1	5.7	6.0	5.3	
98.4	13.4	13.9	14.1	14.6	14.1	13.0	9.0	6.8	5.7	8.2	6.8	5.5	6.0	5.1	
105.0	11.7	11.9	12.1	12.6	13.7	12.6	8.6	6.6	5.7	7.9	6.6	5.3	6.0	5.1	4.0
111.5	9.9	10.1	10.4	10.8	11.7	12.3	8.4	6.4	5.5	7.7	6.4	5.3	6.0	4.9	3.7
118.1	8.4	8.6		9.5	10.1	10.8	7.9	6.2	5.5	7.5	6.2	5.1	5.7	4.6	3.5
124.7	7.3	7.3		8.2	8.8	9.3	7.7	6.0	5.3	7.3	6.0	4.9	5.5	4.6	3.5
131.2	6.2	6.2		7.1	7.5	7.9	7.5	6.0	5.3	7.1	5.7	4.9	5.3	4.4	3.3
144.4	4.2			5.1	5.5		6.2	5.7	5.3	6.4	5.5	4.6	4.9	4.0	3.3
157.5				3.5	3.7		4.6	5.5	5.3	5.3	5.1	4.4	4.2	3.7	3.1
170.6							3.3	4.0		3.7	4.9	4.4	3.7	3.5	2.9
183.7							2.2			2.6	3.5		3.1	3.3	2.9
196.8											2.2		2.2	3.1	2.9
210.0															2.0



ATF 130G-5

Lifting heights / Alturas de elevación

69,224 lbs

SAE

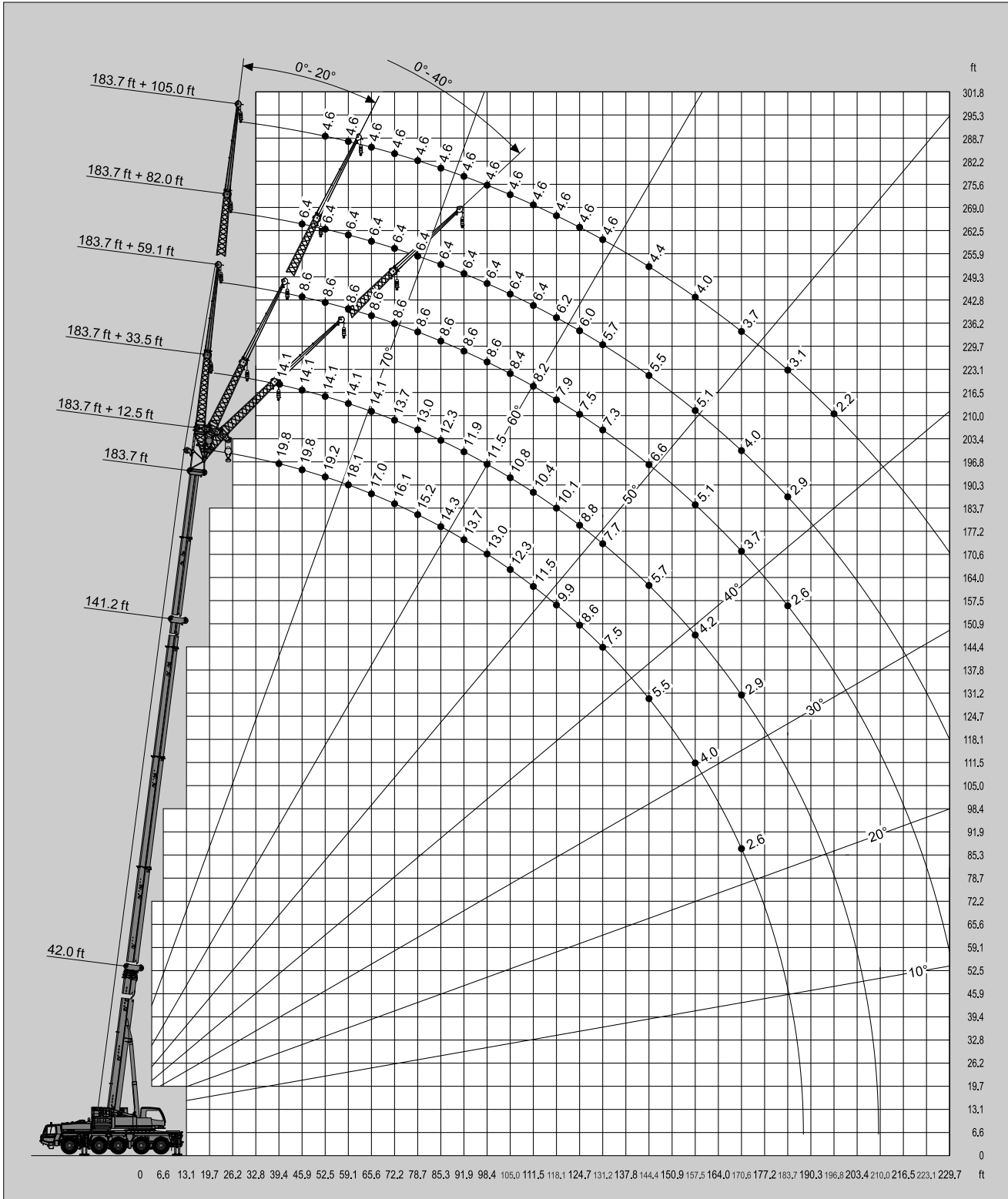



ATF 130G-5

Lifting capacities / Capacidades de elevación

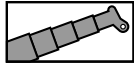

47,178 lbs

SAE

ft	42.0 ft*	42.0 ft	56.2 ft	70.3 ft	84.5 ft	98.7 ft	112.9 ft	127.0 ft	141.2 ft	155.4 ft	169.6 ft	183.7 ft	196.8 ft
8.9	264.6**												
9.8	235.9**	226.9**	198.4	198.4									
11.5	213.8	207.2	198.4	198.4	154.3								
13.1	195.1	190.7	190.5	189.6	154.3								
14.8	177.2	175.0	174.8	173.7	154.3	119.7							
16.4	164.0	160.7	160.5	159.2	154.3	113.1	97.0						
19.7	143.5	135.8	136.7	134.9	135.6	110.2	93.3	72.3					
23.0	127.2	116.6	117.5	117.7	116.4	108.7	84.7	72.3	59.7				
26.2	104.7	101.6	102.3	102.5	100.8	97.9	83.8	72.3	59.7	47.2			
29.5	85.1	85.1	86.0	86.2	88.0	84.2	78.9	66.8	59.7	47.2	36.6		
32.8	71.0	71.0	71.9	72.1	73.6	72.5	72.5	61.9	58.4	47.2	36.6	29.1	
36.1			61.3	61.3	63.1	65.7	64.2	57.8	54.5	47.2	36.6	29.1	23.4
39.4			53.4	54.0	57.1	57.1	55.6	53.6	50.9	47.0	36.6	29.1	23.4
45.9			46.3	45.0	45.2	44.8	43.4	42.1	43.2	41.2	36.6	29.1	23.4
52.5				37.7	38.1	36.2	35.3	36.4	35.1	34.2	34.2	29.1	23.4
59.1				32.0	32.2	30.9	30.9	30.2	29.1	29.8	28.9	28.2	23.4
65.6					27.6	26.7	27.1	26.2	26.0	24.9	25.6	24.9	23.1
72.2					23.8	22.9	23.6	22.5	23.1	22.7	22.0	22.1	20.9
78.7						19.8	20.3	19.2	20.3	19.5	19.7	18.6	18.5
85.3						17.2	17.6	16.5	17.9	17.2	17.2	16.2	16.1
91.9							16.1	15.0	16.1	15.2	15.2	13.9	13.6
98.4							15.0	13.7	14.3	13.1	13.0	12.0	11.8
105.0								12.3	12.8	11.5	11.5	10.1	10.1
111.5								11.5	11.2	10.2	9.7	8.8	8.5
118.1									9.9	9.0	8.6	7.3	7.3
124.7									8.8	7.9	7.3	6.4	6.4
131.2									7.7	7.1	6.4	5.1	5.1
137.8										6.2	5.3	4.2	4.2
144.4										5.3	4.4	3.3	3.3
150.9											4.0	2.6	2.6
157.5											3.1		

* Over rear / * Sobre la parte trasera / ** With additional lifting equipment / ** Con equipo adicional

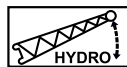
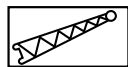
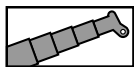

47,178 lbs

SAE

ft	196.8 ft + 12.5 ft			196.8 ft + 33.5 ft			196.8 ft + 59.1 ft			196.8 ft + 82.0 ft			196.8 ft + 105.0 ft		
	0°	20°	40°	0°	20°	40°	0°	20°	40°	0°	20°	40°	0°	20°	40°
39.4				12.6											
45.9	17.2	17.2	17.2	12.6			7.9								
52.5	17.2	16.8	16.3	12.6	12.6		7.9			6.0					
59.1	16.5	15.9	15.4	12.6	12.3		7.9			6.0			4.4		
65.6	15.7	15.2	14.8	12.6	11.9	11.0	7.9			6.0			4.4		
72.2	14.8	14.3	14.1	12.6	11.2	10.6	7.9	7.3		6.0			4.4		
78.7	14.1	13.7	13.4	11.9	10.8	10.1	7.9	7.1		6.0			4.4		
85.3	13.4	13.0	13.0	11.5	10.4	9.9	7.9	6.8	5.7	6.0	6.0		4.4		
91.9	12.1	12.6	12.3	11.0	9.9	9.5	7.9	6.6	5.5	6.0	6.0		4.4		
98.4	10.4	10.6	10.8	10.4	9.7	9.3	7.9	6.4	5.3	6.0	5.7		4.4	4.2	
105.0	8.6	9.0	9.3	8.8	9.3	8.8	7.9	6.2	5.3	6.0	5.5	5.1	4.4	4.2	
111.5	7.3	7.5	7.7	7.5	8.8	8.6	7.5	6.0	5.1	6.0	5.3	5.1	4.4	4.0	
118.1	6.0	6.2	6.4	6.2	7.5	8.2	7.1	6.0	5.1	5.7	5.1	4.9	4.4	4.0	
124.7	4.9	5.1	5.3	5.1	6.4	6.8	6.0	5.7	4.9	5.5	5.1	4.6	4.4	4.0	3.5
131.2	4.0	4.2	4.2	4.2	5.3	5.7	5.1	5.7	4.9	5.3	4.9	4.4	4.2	3.7	3.5
144.4	2.4	2.4	2.6	2.6	3.5	4.0	3.3	4.6	4.6	3.7	4.4	4.2	4.0	3.5	3.3
157.5					2.0	2.4	2.0	3.1	3.7	2.2	3.7	4.0	2.6	3.3	3.1
170.6									2.4		2.4	3.3		3.1	2.9
183.7												2.0		2.0	2.6
196.8															2.0



ATF 130G-5

Lifting heights / Alturas de elevación



SAE

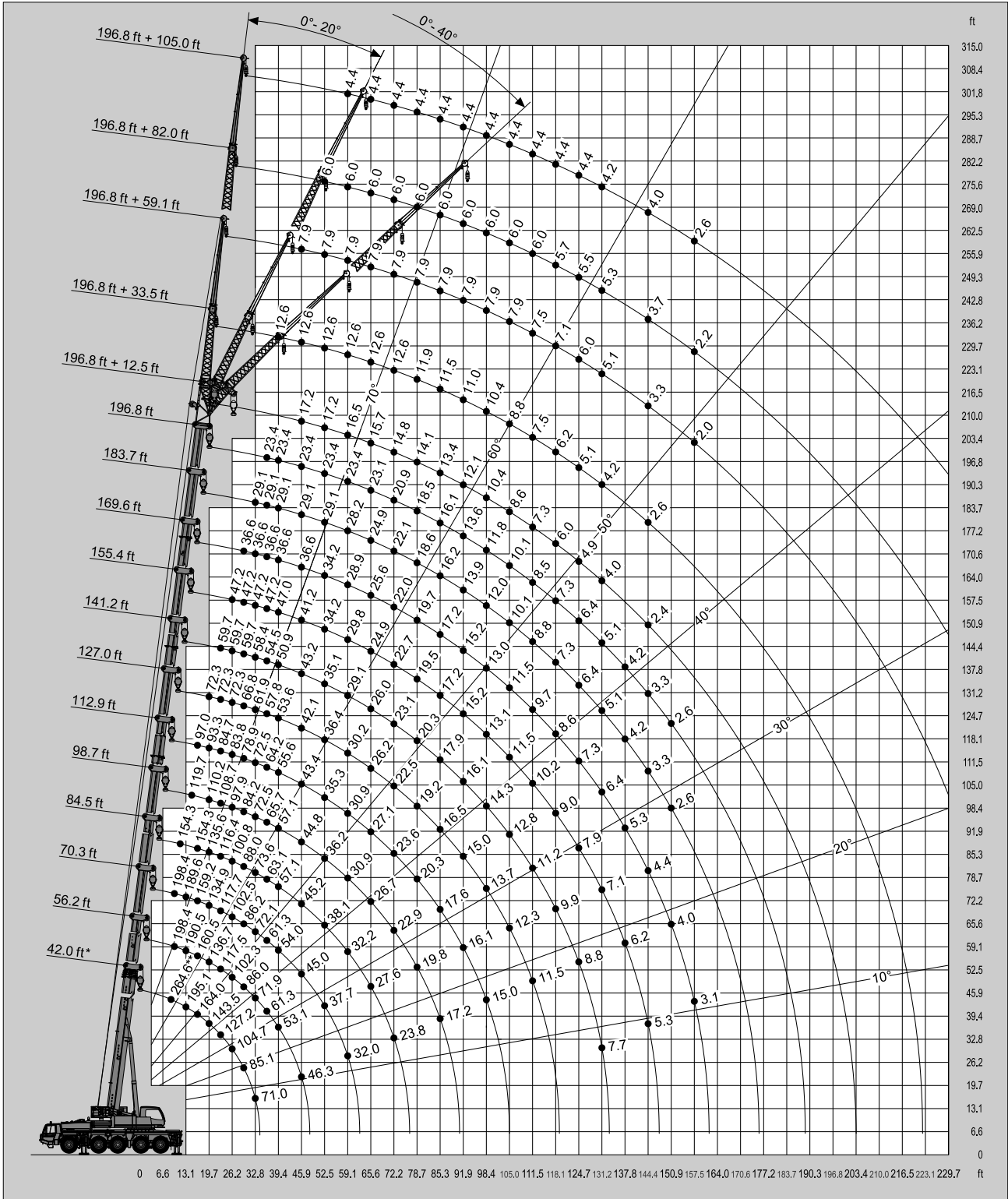

* Over rear / * Sobre la parte trasera
** With additional lifting equipment / ** Con equipo adicional



ATF 130G-5

Lifting capacities / Capacidades de elevación



SAE

ft	183.7 ft + 12.5 ft			183.7 ft + 33.5 ft			183.7 ft + 59.1 ft			183.7 ft + 82.0 ft			183.7 ft + 105.0 ft		
	0°	20°	40°	0°	20°	40°	0°	20°	40°	0°	20°	40°	0°	20°	40°
39.4	19.8	19.8		14.1											
45.9	19.8	19.4	18.7	14.1			8.6			6.4					
52.5	19.2	18.3	17.9	14.1	14.1		8.6			6.4			4.6		
59.1	18.1	17.4	17.0	14.1	13.4	12.6	8.6			6.4			4.6		
65.6	17.0	16.5	16.1	14.1	12.8	11.9	8.6	7.7		6.4			4.6		
72.2	16.1	15.7	15.4	13.7	12.1	11.5	8.6	7.5		6.4			4.6		
78.7	15.2	15.0	14.8	13.0	11.7	11.0	8.6	7.3	6.0	6.4	6.4		4.6		
85.3	14.3	14.1	13.9	12.3	11.2	10.6	8.6	7.1	5.7	6.4	6.4		4.6		
91.9	12.1	12.6	12.8	11.9	10.8	10.1	8.6	6.6	5.5	6.4	6.4		4.6		
98.4	10.4	10.6	10.8	10.6	10.4	9.9	8.6	6.6	5.5	6.4	6.2	5.5	4.6	4.4	
105.0	8.6	9.0	9.3	9.0	10.1	9.5	8.4	6.4	5.3	6.4	6.0	5.3	4.6	4.4	
111.5	7.3	7.5	7.7	7.5	8.8	9.3	8.2	6.2	5.3	6.4	5.7	5.3	4.6	4.2	
118.1	6.2	6.2	6.4	6.4	7.5	8.2	7.3	6.0	5.1	6.2	5.5	5.1	4.6	4.2	
124.7	4.9	5.3	5.3	5.3	6.4	7.1	6.2	5.7	5.1	6.0	5.3	4.9	4.6	4.0	3.5
131.2	4.0	4.2	4.4	4.4	5.3	5.7	5.3	5.7	5.1	5.5	5.1	4.9	4.6	4.0	3.5
144.4	2.4	2.6	2.6	2.6	3.5	4.0	3.5	4.6	4.9	4.0	4.9	4.4	4.2	3.7	3.3
157.5					2.2	2.4	2.2	3.1	4.0	2.4	4.0	4.2	2.9	3.5	3.1
170.6								2.0	2.4		2.6	3.5	3.3	3.1	3.1
183.7												2.2	2.0	2.9	2.9
196.8														2.0	2.0

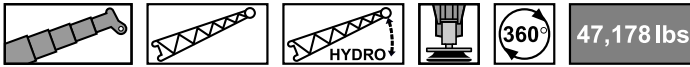

SAE

ft	141.2 ft + 12.5 ft			141.2 ft + 33.5 ft			141.2 ft + 59.1 ft			141.2 ft + 82.0 ft			141.2 ft + 105.0 ft		
	0°	20°	40°	0°	20°	40°	0°	20°	40°	0°	20°	40°	0°	20°	40°
26.2				23.4											
29.5	36.6	33.1	31.1	23.4											
32.8	34.8	31.7	30.0	23.4			12.1								
36.1	33.5	30.6	28.9	23.4			12.1			8.4					
39.4	32.2	29.5	28.0	23.4	22.3		12.1			8.4			6.0		
45.9	29.8	27.6	26.2	23.4	20.7	18.1	12.1			8.4			6.0		
52.5	27.8	26.0	24.9	23.1	19.6	17.0	12.1	9.0		8.4			6.0		
59.1	26.2	24.5	23.6	21.8	18.3	16.3	11.9	8.6		8.4			6.0		
65.6	22.7	23.4	22.7	20.5	17.4	15.7	11.5	8.2	6.6	8.4	7.9		6.0		
72.2	18.7	19.2	19.8	19.4	16.5	15.0	10.8	7.9	6.4	8.4	7.7		6.0		
78.7	15.4	15.9	16.3	16.5	15.9	14.3	10.4	7.5	6.2	8.4	7.5		6.0	5.7	
85.3	12.8	13.2	13.7	13.9	15.2	13.9	9.9	7.3	6.0	8.4	7.3	6.0	6.0	5.5	
91.9	10.6	11.0	11.2	11.7	12.8	13.4	9.5	7.1	6.0	8.2	7.1	5.7	6.0	5.3	
98.4	8.8	9.0	9.3	9.7	10.8	11.7	9.0	6.8	5.7	8.2	6.8	5.5	6.0	5.1	
105.0	7.1	7.5	7.7	8.2	9.0	9.9	8.6	6.6	5.7	7.9	6.6	5.3	6.0	5.1	4.0
111.5	5.7	6.0	6.2	6.8	7.7	8.2	8.2	6.4	5.5	7.7	6.4	5.3	6.0	4.9	3.7
118.1	4.6	4.9		5.5	6.4	6.8	6.8	6.2	5.5	7.5	6.2	5.1	5.7	4.6	3.5
124.7	3.5	3.7		4.4	5.1	5.5	5.7	6.0	5.3	6.4	6.0	4.9	5.5	4.6	3.5
131.2	2.6	2.6		3.5	4.2	4.4	4.9	6.0	5.3	5.3	5.7	4.9	5.3	4.4	3.3
144.4				2.0	2.4		3.1	4.2	4.9	3.7	5.1	4.6	4.2	4.0	3.3
157.5								2.6	3.1	2.4	3.5	4.4	2.9	3.7	3.1
170.6											2.2	2.9	3.1	2.9	2.9
183.7													2.0	2.9	2.9



ATF 130G-5

Lifting heights / Alturas de elevación

47,178 lbs

SAE

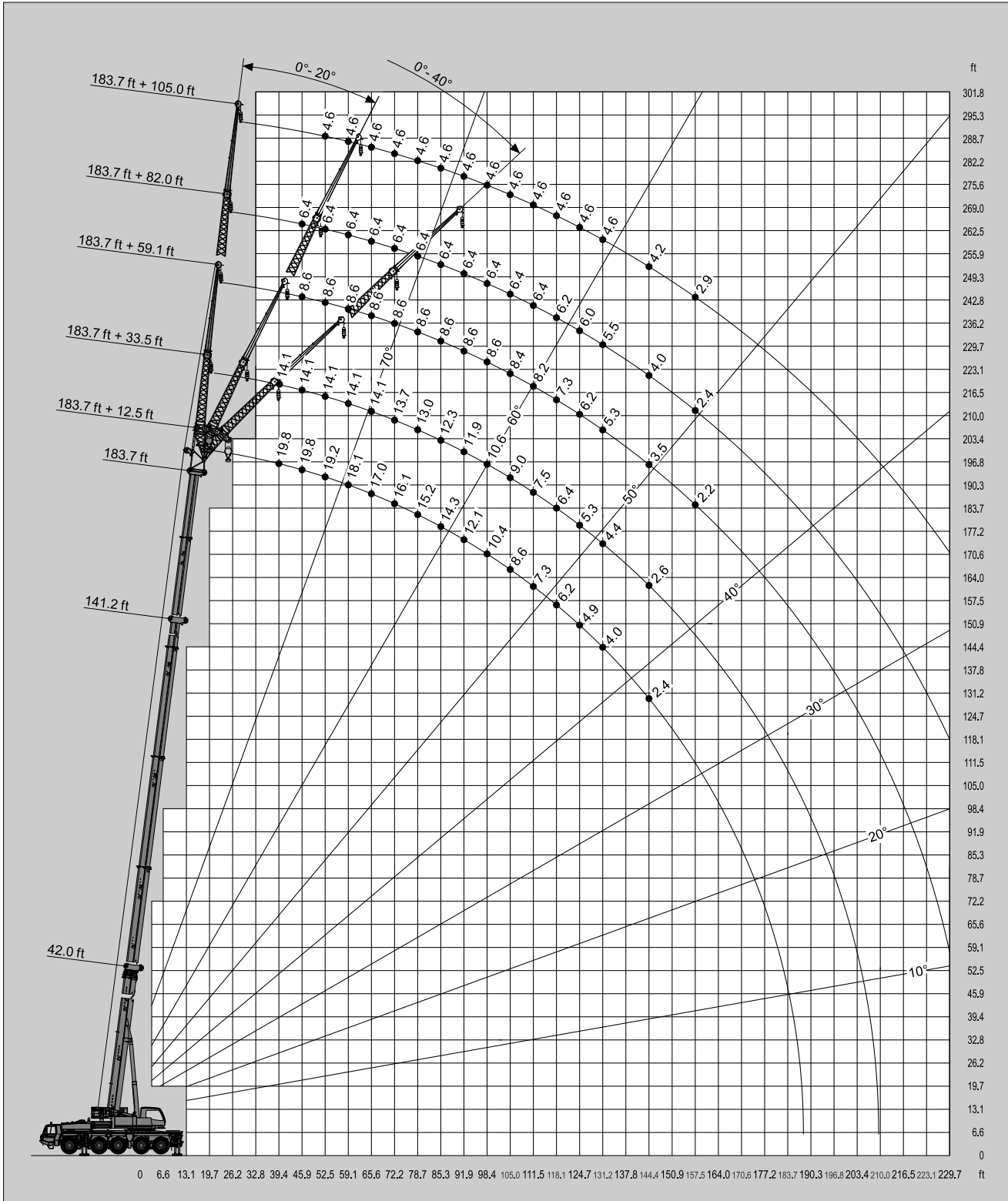



ATF 130G-5

Lifting capacities / Capacidades de elevación

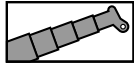

27,558 lbs

SAE

ft	42.0 ft*	42.0 ft	56.2 ft	70.3 ft	84.5 ft	98.7 ft	112.9 ft	127.0 ft	141.2 ft	155.4 ft	169.6 ft	183.7 ft	196.8 ft
8.9	264.6**												
9.8	235.7**	225.1**	198.4	198.4									
11.5	212.5	205.2	198.4	198.4	154.3								
13.1	192.0	187.0	186.7	185.6	154.3								
14.8	175.0	169.3	168.9	167.8	154.3	119.7							
16.4	162.7	153.9	154.8	152.6	153.9	113.1	97.0						
19.7	142.4	129.4	130.3	130.5	122.8	110.2	93.3	72.3					
23.0	109.8	109.8	111.1	108.0	102.7	95.7	84.7	72.3	59.7				
26.2	85.1	85.1	86.2	86.4	86.2	80.9	78.3	72.1	59.7	47.2			
29.5	68.6	68.6	69.7	69.9	71.6	71.9	66.6	61.5	58.9	47.2	36.6		
32.8	57.1	57.1	59.3	61.3	63.1	62.2	57.8	53.4	51.1	47.2	36.6	29.1	
36.1			53.1	53.6	53.8	53.4	50.5	48.3	46.7	43.9	36.6	29.1	23.4
39.4			46.8	46.3	46.7	46.1	44.8	44.8	41.4	40.8	36.6	29.1	23.4
45.9			36.8	37.7	37.7	35.7	36.8	35.9	34.6	33.3	31.5	29.1	23.4
52.5				30.7	30.7	29.5	30.4	28.4	29.4	29.3	27.8	25.8	23.4
59.1				25.1	25.7	24.3	24.9	23.6	25.1	24.3	23.4	22.0	21.2
65.6					21.7	20.3	22.0	20.9	21.6	20.1	20.2	18.8	18.3
72.2					18.7	17.4	19.2	18.2	18.5	17.2	16.9	16.0	15.9
78.7						15.4	16.8	15.9	16.0	14.9	14.3	13.5	13.4
85.3						13.9	14.3	13.9	13.7	12.8	12.1	11.1	11.1
91.9							12.1	11.9	11.7	11.0	10.1	9.3	9.3
98.4							10.6	10.1	9.9	9.3	8.6	7.3	7.3
105.0								8.8	8.6	7.7	7.1	5.7	5.7
111.5								7.5	7.3	6.6	5.7	4.6	4.6
118.1									6.4	5.4	4.6	3.7	3.7
124.7									5.3	4.4	3.7	2.6	2.6
131.2									4.4	3.7	2.9		
137.8										2.9	2.2		
144.4										2.2			

* Over rear / * Sobre la parte trasera / ** With additional lifting equipment / ** Con equipo adicional

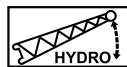
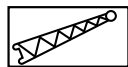
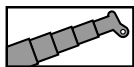

27,558 lbs

SAE

ft	196.8 ft + 12.5 ft			196.8 ft + 33.5 ft			196.8 ft + 59.1 ft			196.8 ft + 82.0 ft			196.8 ft + 105.0 ft		
	0°	20°	40°	0°	20°	40°	0°	20°	40°	0°	20°	40°	0°	20°	40°
39.4				12.6											
45.9	17.2	17.2	17.2	12.6			7.9								
52.5	17.2	16.8	16.3	12.6	12.6		7.9			6.0					
59.1	16.5	15.9	15.4	12.6	12.3		7.9			6.0			4.4		
65.6	15.7	15.2	14.8	12.6	11.9	11.0	7.9			6.0			4.4		
72.2	14.1	14.3	14.1	12.6	11.2	10.6	7.9	7.3		6.0			4.4		
78.7	11.7	12.1	12.6	11.5	10.8	10.1	7.9	7.1		6.0			4.4		
85.3	9.5	9.9	10.1	9.7	10.4	9.9	7.9	6.8	5.7	6.0	6.0		4.4		
91.9	7.7	7.9	8.4	7.9	9.5	9.5	7.9	6.6	5.5	6.0	6.0		4.4		
98.4	6.2	6.4	6.6	6.2	7.9	8.8	7.3	6.4	5.3	6.0	5.7		4.4	4.2	
105.0	4.9	5.1	5.3	5.1	6.4	7.3	6.0	6.2	5.3	6.0	5.5	5.1	4.4	4.2	
111.5	3.5	4.0	4.0	3.7	5.3	6.0	4.9	6.0	5.1	5.1	5.3	5.1	4.4	4.0	
118.1	2.6	2.9	3.1	2.9	4.0	4.9	3.7	5.3	5.1	4.0	5.1	4.9	4.4	4.0	
124.7		2.0	2.2	2.0	3.1	3.7	2.9	4.4	4.9	3.1	5.1	4.6	3.5	4.0	3.5
131.2					2.2	2.9		3.5	4.4		4.2	4.4		3.7	3.5
144.4									2.9		2.6	4.0		3.3	3.3
157.5															3.1



ATF 130G-5

Lifting heights / Alturas de elevación

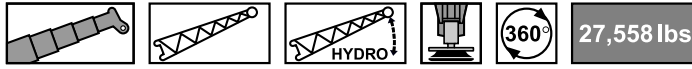

SAE

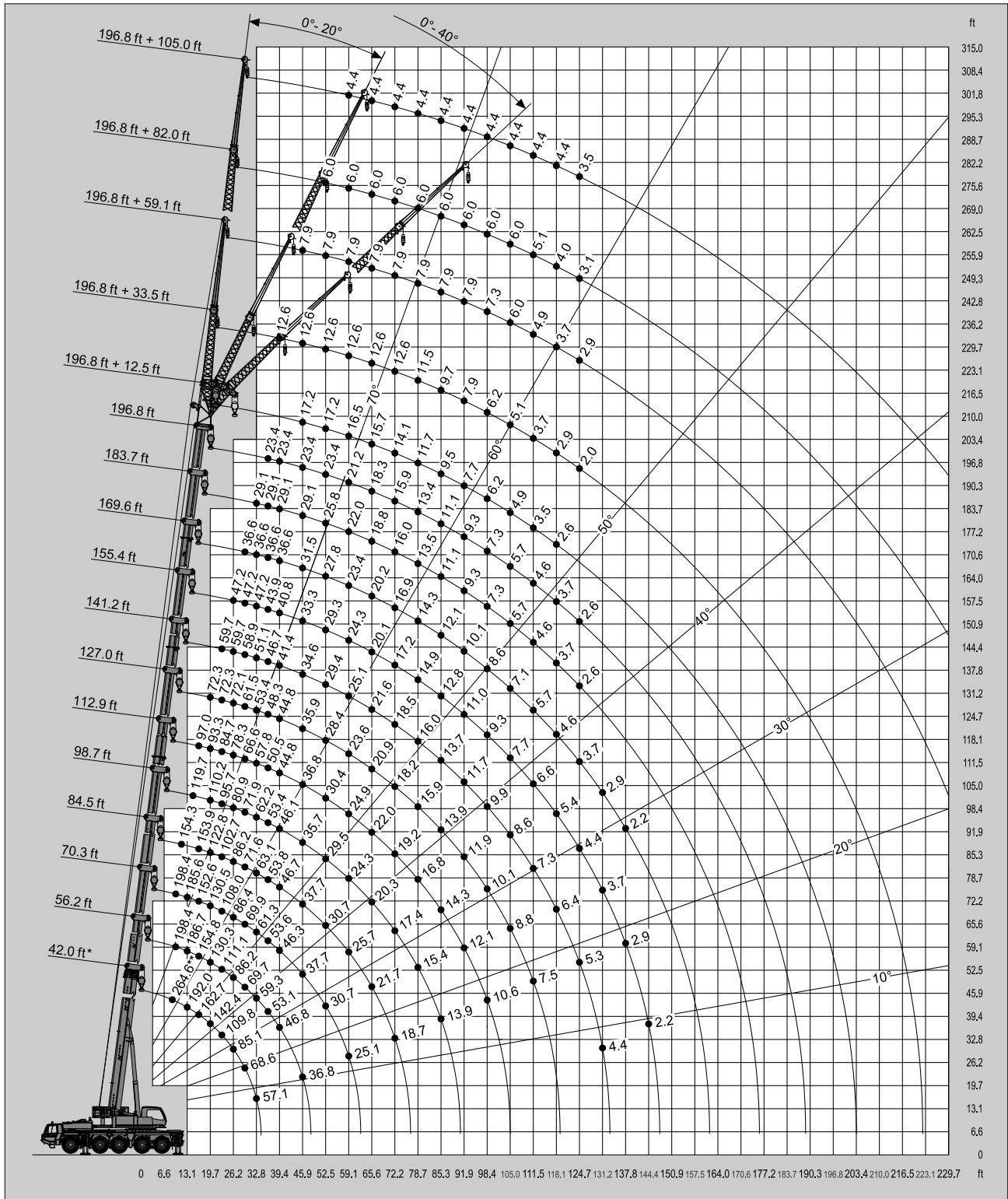

* Over rear / * Sobre la parte trasera
** With additional lifting equipment / ** Con equipo adicional



ATF 130G-5

Lifting capacities / Capacidades de elevación

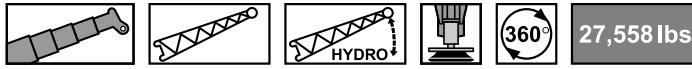

SAE

ft	183.7 ft + 12.5 ft			183.7 ft + 33.5 ft			183.7 ft + 59.1 ft			183.7 ft + 82.0 ft			183.7 ft + 105.0 ft		
	0°	20°	40°	0°	20°	40°	0°	20°	40°	0°	20°	40°	0°	20°	40°
39.4	19.8	19.8		14.1											
45.9	19.8	19.4	18.7	14.1			8.6			6.4					
52.5	19.2	18.3	17.9	14.1	14.1		8.6			6.4			4.6		
59.1	18.1	17.4	17.0	14.1	13.4	12.6	8.6			6.4			4.6		
65.6	17.0	16.5	16.1	14.1	12.8	11.9	8.6	7.7		6.4			4.6		
72.2	14.3	15.0	15.2	13.7	12.1	11.5	8.6	7.5		6.4			4.6		
78.7	11.7	12.1	12.6	11.9	11.7	11.0	8.6	7.3	6.0	6.4	6.4		4.6		
85.3	9.5	9.9	10.1	9.7	11.2	10.6	8.6	7.1	5.7	6.4	6.4		4.6		
91.9	7.7	8.2	8.4	7.9	9.7	10.1	8.6	6.6	5.5	6.4	6.4		4.6		
98.4	6.2	6.4	6.6	6.4	7.9	8.8	7.5	6.6	5.5	6.4	6.2	5.5	4.6	4.4	
105.0	4.9	5.1	5.3	5.1	6.6	7.3	6.2	6.4	5.3	6.4	6.0	5.3	4.6	4.4	
111.5	3.7	4.0	4.2	4.0	5.3	6.0	4.9	6.2	5.3	5.3	5.7	5.3	4.6	4.2	
118.1	2.6	2.9	3.1	2.9	4.2	4.9	4.0	5.5	5.1	4.2	5.5	5.1	4.6	4.2	
124.7		2.0	2.2	2.0	3.1	3.7	3.1	4.4	5.1	3.3	5.3	4.9	3.7	4.0	3.5
131.2					2.4	2.9	2.2	3.5	4.6	2.6	4.4	4.9	2.9	4.0	3.5
144.4								2.0	2.9		2.6	4.0		3.5	3.3
157.5											2.4				3.1

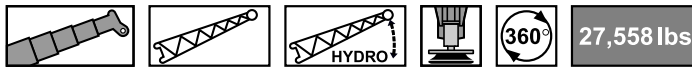

SAE

ft	141.2 ft + 12.5 ft			141.2 ft + 33.5 ft			141.2 ft + 59.1 ft			141.2 ft + 82.0 ft			141.2 ft + 105.0 ft		
	0°	20°	40°	0°	20°	40°	0°	20°	40°	0°	20°	40°	0°	20°	40°
26.2				23.4											
29.5	36.6	33.1	31.1	23.4											
32.8	34.8	31.7	30.0	23.4			12.1								
36.1	33.5	30.6	28.9	23.4			12.1								
39.4	32.2	29.5	28.0	23.4	22.3		12.1			8.4					
45.9	29.8	27.6	26.2	23.4	20.7	18.1	12.1			8.4			6.0		
52.5	24.9	25.6	24.9	23.1	19.6	17.0	12.1	9.0		8.4			6.0		
59.1	20.3	20.9	21.6	20.5	18.3	16.3	11.9	8.6		8.4			6.0		
65.6	16.1	16.5	17.2	17.0	17.4	15.7	11.5	8.2	6.6	8.4	7.9		6.0		
72.2	12.8	13.2	13.9	13.7	15.4	15.0	10.8	7.9	6.4	8.4	7.7		6.0		
78.7	10.1	10.6	11.0	11.0	12.6	13.9	10.4	7.5	6.2	8.4	7.5		6.0	5.7	
85.3	7.9	8.4	8.8	8.8	10.4	11.5	9.9	7.3	6.0	8.4	7.3	6.0	6.0	5.5	
91.9	6.2	6.4	6.8	7.1	8.4	9.3	8.6	7.1	6.0	8.2	7.1	5.7	6.0	5.3	
98.4	4.6	4.9	5.3	5.5	6.6	7.5	7.1	6.8	5.7	7.7	6.8	5.5	6.0	5.1	
105.0	3.3	3.5	3.7	4.2	5.3	6.0	5.7	6.6	5.7	6.4	6.6	5.3	6.0	5.1	4.0
111.5	2.2	2.4	2.6	3.1	4.0	4.6	4.4	6.2	5.5	5.1	6.4	5.3	5.7	4.9	3.7
118.1				2.2	2.9	3.5	3.5	5.1	5.5	4.0	6.2	5.1	4.6	4.6	3.5
124.7					2.0	2.4	2.6	4.0	5.1	3.1	5.1	4.9	3.7	4.6	3.5
131.2								3.1	4.0	2.4	4.0	4.9	2.9	4.4	3.3
144.4									2.2		2.4	3.5		3.5	3.3
157.5											2.0			2.0	3.1
170.6															2.0



ATF 130G-5

Lifting heights / Alturas de elevación

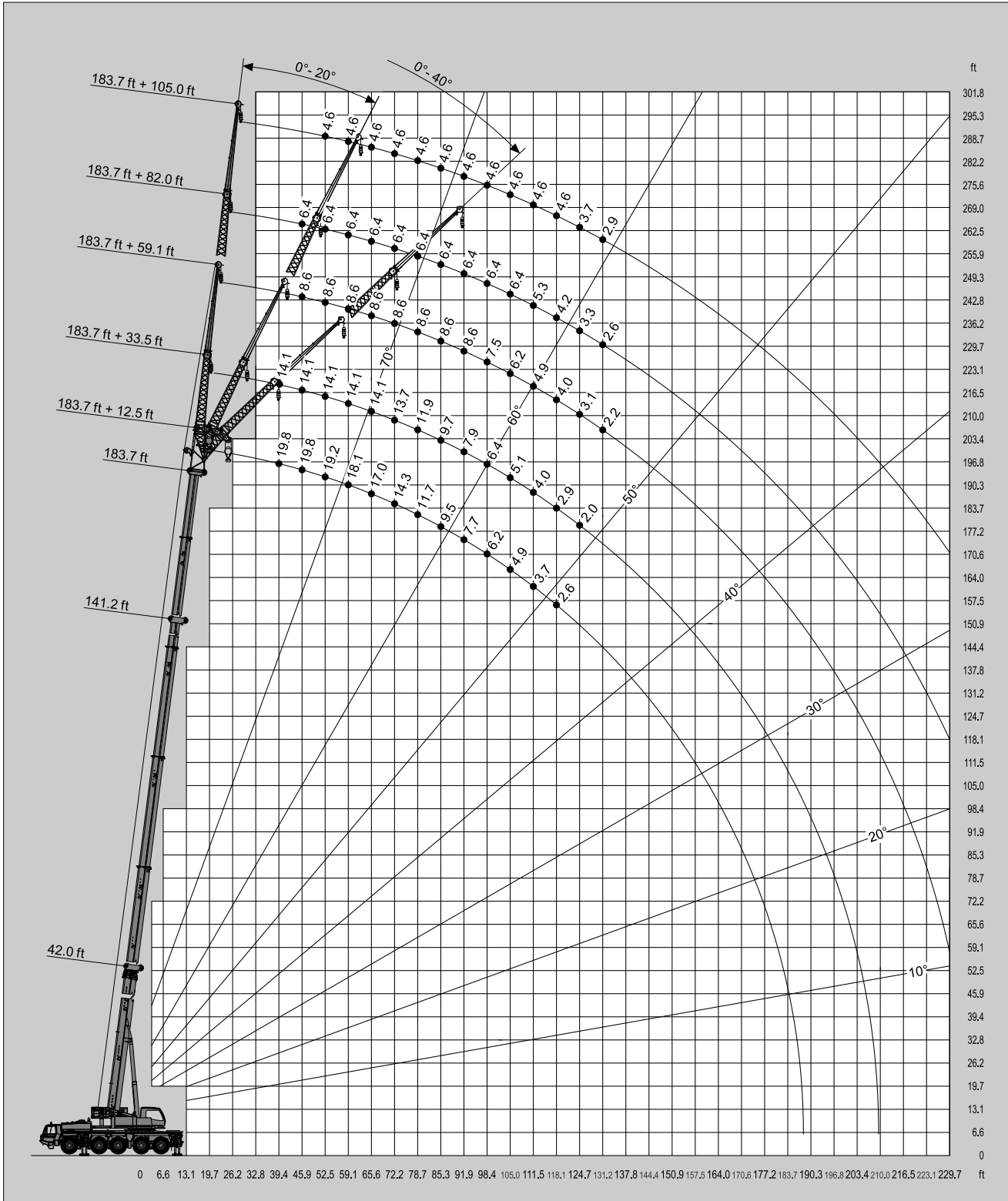
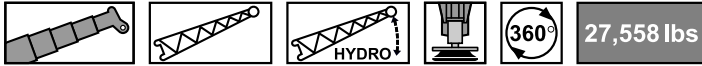



ATF 130G-5

Lifting capacities / Capacidades de elevación

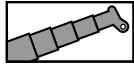

20,062 lbs

SAE

ft	42.0 ft*	42.0 ft	56.2 ft	70.3 ft	84.5 ft	98.7 ft	112.9 ft	127.0 ft	141.2 ft	155.4 ft	169.6 ft	183.7 ft	196.8 ft
8.9	264.6**												
9.8	235.7**	224.4**	198.4	198.4									
11.5	212.5	203.7	198.4	198.4	154.3								
13.1	191.8	184.3	184.1	184.1	182.8	154.3							
14.8	174.6	166.4	166.2	164.9	154.3	119.7							
16.4	162.3	151.2	152.1	149.7	146.4	113.1	97.0						
19.7	138.2	126.8	127.6	124.3	112.9	107.6	93.3	72.3					
23.0	100.3	100.3	101.6	99.2	95.0	87.3	83.8	72.3	59.7				
26.2	77.6	77.6	78.7	78.9	78.0	76.7	70.5	64.8	59.7	47.2			
29.5	62.4	62.4	65.0	65.9	69.0	65.0	60.0	55.1	52.7	47.2	36.6		
32.8	51.6	51.6	57.1	57.3	57.5	56.0	51.8	51.1	47.4	44.3	36.6	29.1	
36.1			48.9	50.1	50.6	48.5	45.4	45.2	41.7	41.0	36.6	29.1	23.4
39.4			42.3	44.2	44.6	42.8	43.0	39.9	37.7	36.6	34.2	29.1	23.4
45.9			32.8	34.4	34.8	33.7	34.2	32.2	31.7	31.5	29.8	27.6	23.4
52.5				27.1	27.9	26.9	27.6	26.5	27.8	26.0	24.5	22.7	22.0
59.1				22.0	23.2	21.6	23.4	22.9	23.3	22.2	20.9	19.4	18.7
65.6					19.6	18.7	19.7	19.8	19.2	18.4	17.6	16.4	16.3
72.2					16.5	16.3	17.0	16.8	16.2	15.5	14.7	13.6	13.7
78.7						14.1	14.3	14.1	13.9	13.0	12.3	11.2	11.2
85.3						11.9	12.1	11.7	11.7	11.0	10.1	9.0	9.0
91.9							10.1	9.9	9.7	9.0	8.2	7.3	7.3
98.4							8.8	8.2	8.2	7.5	6.8	5.5	5.5
105.0								7.1	6.8	6.2	5.3	4.4	4.4
111.5								5.7	5.7	4.9	4.4	3.1	3.1
118.1									4.9	4.0	3.1	2.2	2.2
124.7									4.0	3.1	2.4		
131.2									3.1	2.2			

* Over rear / * Sobre la parte trasera / ** With additional lifting equipment / ** Con equipo adicional

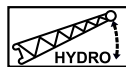
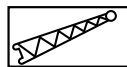
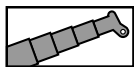

20,062 lbs

SAE

ft	196.8 ft + 12.5 ft			196.8 ft + 33.5 ft			196.8 ft + 59.1 ft			196.8 ft + 82.0 ft			196.8 ft + 105.0 ft		
	0°	20°	40°	0°	20°	40°	0°	20°	40°	0°	20°	40°	0°	20°	40°
39.4				12.6											
45.9	17.2	17.2	17.2	12.6			7.9								
52.5	17.2	16.8	16.3	12.6	12.6		7.9			6.0					
59.1	16.5	15.9	15.4	12.6	12.3		7.9			6.0			4.4		
65.6	14.1	14.8	14.8	12.6	11.9	11.0	7.9			6.0			4.4		
72.2	11.7	12.1	12.6	11.5	11.2	10.6	7.9	7.3		6.0			4.4		
78.7	9.7	10.1	10.4	9.5	10.8	10.1	7.9	7.1		6.0			4.4		
85.3	7.5	7.9	8.4	7.7	9.3	9.9	7.9	6.8	5.7	6.0	6.0		4.4		
91.9	6.0	6.4	6.6	6.2	7.7	8.8	6.8	6.6	5.5	6.0	6.0		4.4		
98.4	4.4	4.9	5.1	4.6	6.2	7.3	5.7	6.4	5.3	5.7	5.7		4.4	4.2	
105.0	3.3	3.5	3.7	3.5	4.9	5.7	4.4	6.2	5.3	4.6	5.5	5.1	4.4	4.2	
111.5	2.2	2.4	2.6		3.7	4.4	3.3	5.1	5.1	3.7	5.3	5.1	4.0	4.0	
118.1					2.9	3.5		4.0	5.1		4.9	4.9		4.0	
124.7						2.4		3.1	4.4		4.0	4.6		4.0	
131.2									3.3		3.1	4.4		3.7	
144.4												2.9			
157.5															



ATF 130G-5

Lifting heights / Alturas de elevación

20,062 lbs

SAE

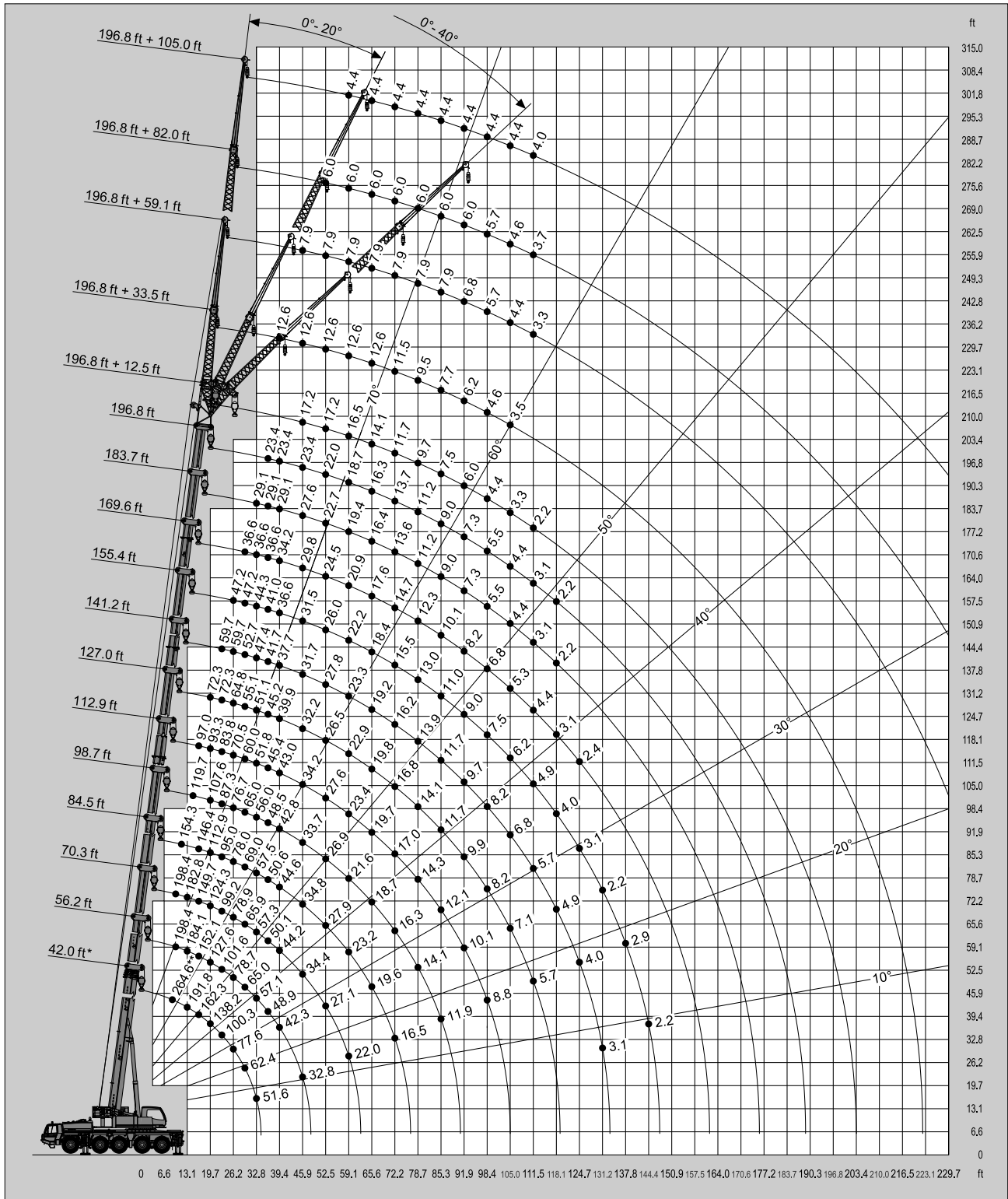

* Over rear / * Sobre la parte trasera
** With additional lifting equipment / ** Con equipo adicional



ATF 130G-5

Lifting capacities / Capacidades de elevación



SAE

ft	183.7 ft + 12.5 ft			183.7 ft + 33.5 ft			183.7 ft + 59.1 ft			183.7 ft + 82.0 ft			183.7 ft + 105.0 ft		
	0°	20°	40°	0°	20°	40°	0°	20°	40°	0°	20°	40°	0°	20°	40°
39.4	19.8	19.8		14.1											
45.9	19.8	19.4	18.7	14.1			8.6			6.4					
52.5	19.2	18.3	17.9	14.1	14.1		8.6			6.4			4.6		
59.1	17.6	17.4	17.0	14.1	13.4	12.6	8.6			6.4			4.6		
65.6	14.6	15.0	15.4	14.1	12.8	11.9	8.6	7.7		6.4			4.6		
72.2	12.1	12.6	13.0	11.9	12.1	11.5	8.6	7.5		6.4			4.6		
78.7	9.7	10.1	10.4	9.9	11.5	11.0	8.6	7.3	6.0	6.4	6.4		4.6		
85.3	7.7	7.9	8.4	7.9	9.7	10.6	8.6	7.1	5.7	6.4	6.4		4.6		
91.9	6.0	6.4	6.6	6.2	7.9	8.8	7.3	6.6	5.5	6.4	6.4		4.6		
98.4	4.6	4.9	5.1	4.9	6.4	7.3	6.0	6.6	5.5	6.2	6.2	5.5	4.6	4.4	
105.0	3.3	3.5	3.7	3.5	5.1	5.7	4.6	6.4	5.3	5.1	6.0	5.3	4.6	4.4	
111.5	2.2	2.6	2.6	2.6	4.0	4.6	3.5	5.3	5.3	4.0	5.7	5.3	4.2	4.2	
118.1					2.9	3.5	2.6	4.2	5.1	2.9	5.1	5.1	3.3	4.2	
124.7					2.0	2.6		3.3	4.4		4.0	4.9		4.0	
131.2								2.4	3.5		3.1	4.6		4.0	
144.4												2.9			

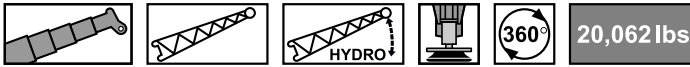

SAE

ft	141.2 ft + 12.5 ft			141.2 ft + 33.5 ft			141.2 ft + 59.1 ft			141.2 ft + 82.0 ft			141.2 ft + 105.0 ft		
	0°	20°	40°	0°	20°	40°	0°	20°	40°	0°	20°	40°	0°	20°	40°
26.2				23.4											
29.5	36.6	33.1	31.1	23.4											
32.8	34.8	31.7	30.0	23.4			12.1								
36.1	33.5	30.6	28.9	23.4			12.1			8.4					
39.4	32.2	29.5	28.0	23.4	22.3		12.1			8.4			6.0		
45.9	26.9	27.6	26.2	23.4	20.7	18.1	12.1			8.4			6.0		
52.5	21.6	22.3	22.9	21.4	19.6	17.0	12.1	9.0		8.4			6.0		
59.1	17.2	18.1	18.7	17.6	18.3	16.3	11.9	8.6		8.4			6.0		
65.6	13.4	14.1	14.6	14.3	16.3	15.7	11.5	8.2	6.6	8.4	7.9		6.0		
72.2	10.4	11.0	11.5	11.5	13.2	14.6	10.8	7.9	6.4	8.4	7.7		6.0		
78.7	7.9	8.4	8.8	9.0	10.6	11.9	10.4	7.5	6.2	8.4	7.5		6.0	5.7	
85.3	6.0	6.4	6.8	7.1	8.4	9.5	8.6	7.3	6.0	8.4	7.3	6.0	6.0	5.5	
91.9	4.4	4.6	5.1	5.3	6.6	7.5	6.8	7.1	6.0	7.5	7.1	5.7	6.0	5.3	
98.4	3.1	3.3	3.5	4.0	5.1	6.0	5.5	6.8	5.7	6.0	6.8	5.5	6.0	5.1	
105.0		2.0	2.4	2.6	3.7	4.4	4.2	6.0	5.7	4.9	6.6	5.3	5.3	5.1	4.0
111.5					2.6	3.3	3.1	4.9	5.5	3.7	6.0	5.3	4.4	4.9	3.7
118.1						2.2	2.2	3.7	4.9	2.9	4.9	5.1	3.3	4.6	3.5
124.7								2.6	3.7	2.0	3.7	4.9	2.4	4.6	3.5
131.2									2.6		2.9	4.4		4.0	3.3
144.4												2.4		2.4	3.3
157.5															2.4



ATF 130G-5

Lifting heights / Alturas de elevación

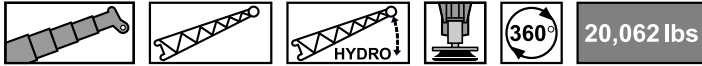

SAE

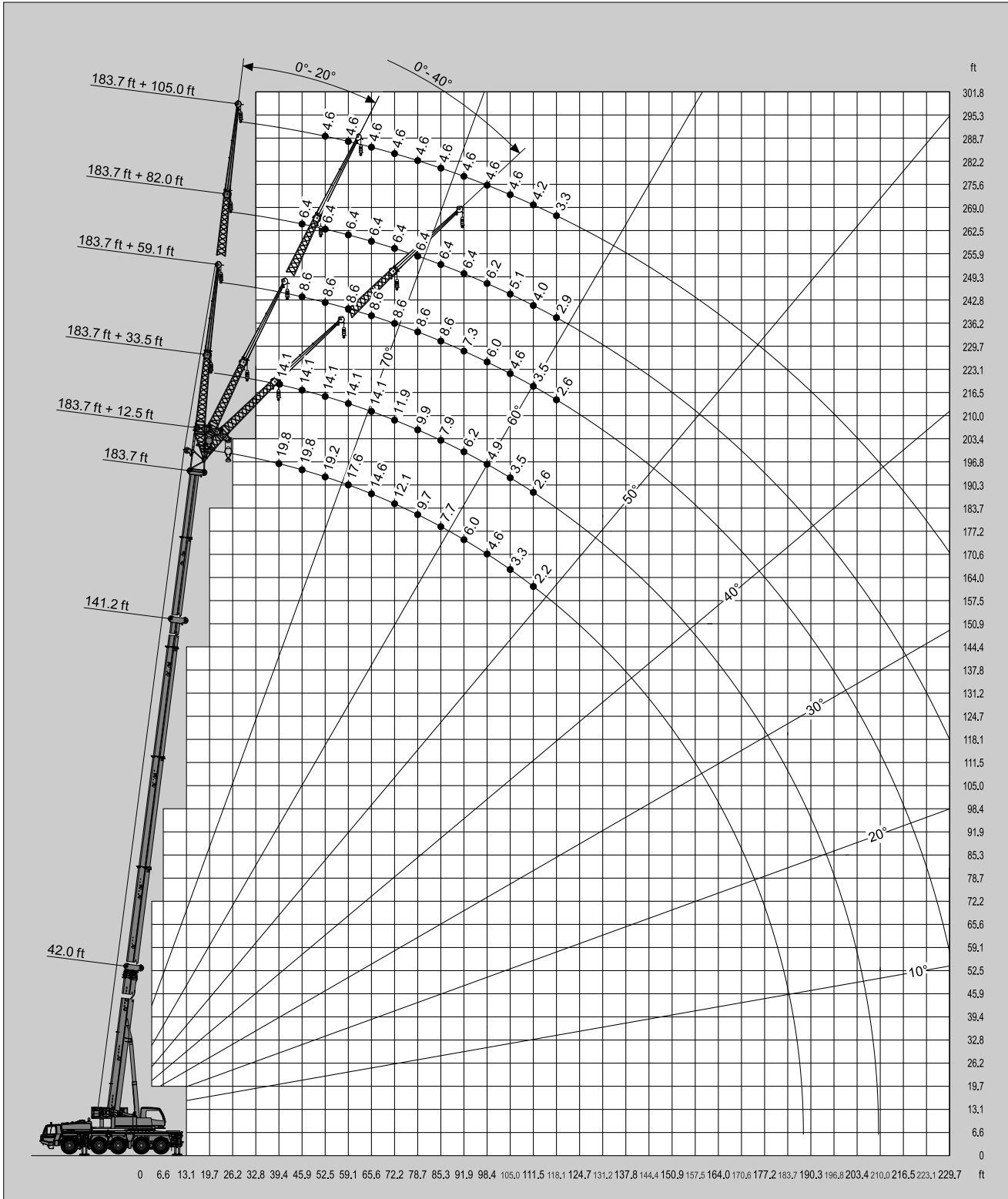



ATF 130G-5

Lifting capacities / Capacidades de elevación

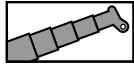

13,228 lbs

SAE

ft	42.0 ft*	42.0 ft	56.2 ft	70.3 ft	84.5 ft	98.7 ft	112.9 ft	127.0 ft	141.2 ft	155.4 ft	169.6 ft	183.7 ft	196.8 ft
8.9	264.6**												
9.8	235.7**	224.0**	198.4	198.4									
11.5	211.9	202.4	198.4	198.4	154.3								
13.1	191.1	181.7	181.2	181.2	154.3								
14.8	174.2	163.8	164.2	162.3	154.3	119.7							
16.4	161.8	148.6	149.5	149.0	134.9	113.1	97.0						
19.7	126.8	124.3	124.6	114.4	108.2	99.0	89.7	72.3					
23.0	91.7	91.7	93.0	90.2	86.2	84.0	76.7	69.9	59.7				
26.2	70.5	70.5	71.9	72.1	74.5	69.4	63.5	58.2	55.3	47.2			
29.5	56.7	56.7	60.8	62.8	62.6	58.6	53.8	53.1	48.9	45.6	36.6		
32.8	46.7	46.7	52.2	52.5	52.7	50.3	48.3	46.1	42.3	41.0	36.6	29.1	
36.1			44.8	45.9	44.8	43.9	43.7	40.3	39.5	36.8	34.2	29.1	23.4
39.4			38.4	39.9	39.7	37.9	38.6	35.7	35.3	34.6	31.5	29.1	23.4
45.9			28.9	30.6	31.7	30.0	30.9	29.8	29.8	28.0	26.2	24.3	23.4
52.5				24.3	25.1	24.0	25.6	25.1	24.3	22.9	21.6	19.6	19.2
59.1				19.4	20.5	20.5	20.9	20.7	20.3	19.4	18.5	16.8	15.9
65.6					17.0	17.0	17.2	17.2	17.0	16.1	15.4	14.1	13.7
72.2					14.1	14.1	14.3	14.3	14.3	13.0	12.6	11.5	11.2
78.7						11.9	12.1	11.9	11.9	10.8	10.1	9.0	9.0
85.3						9.9	10.1	9.9	9.7	9.0	8.2	7.1	7.1
91.9							8.6	8.2	7.9	7.3	6.6	5.3	5.3
98.4							7.3	6.8	6.6	5.7	5.1	4.0	4.0
105.0								5.5	5.3	4.6	4.0	2.9	2.9
111.5								4.6	4.4	3.7	2.9		
118.1									3.3	2.6			
124.7									2.6				

* Over rear / * Sobre la parte trasera / ** With additional lifting equipment / ** Con equipo adicional

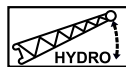
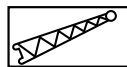
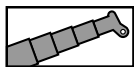

13,228 lbs

SAE

ft	196.8 ft + 12.5 ft			196.8 ft + 33.5 ft			196.8 ft + 59.1 ft			196.8 ft + 82.0 ft			196.8 ft + 105.0 ft		
	0°	20°	40°	0°	20°	40°	0°	20°	40°	0°	20°	40°	0°	20°	40°
39.4				12.6											
45.9	17.2	17.2	17.2	12.6			7.9								
52.5	17.2	16.8	16.3	12.6	12.6		7.9			6.0					
59.1	14.6	15.2	15.4	12.6	12.3		7.9			6.0			4.4		
65.6	12.3	12.8	12.8	11.5	11.9	11.0	7.9			6.0			4.4		
72.2	10.4	10.8	11.0	9.7	11.2	10.6	7.9	7.3		6.0			4.4		
78.7	8.4	8.8	9.0	7.9	9.9	10.1	7.9	7.1		6.0			4.4		
85.3	6.6	6.8	7.3	6.4	8.2	9.0	6.8	6.8	5.7	6.0	6.0		4.4		
91.9	4.9	5.1	5.3	4.9	6.8	7.5	5.5	6.6	5.5	5.3	6.0		4.4		
98.4	3.3	3.7	4.0	3.7	5.3	6.2	4.6	6.4	5.3	4.6	5.7		4.4		
105.0					4.0	4.9		5.3	5.3		5.5	5.1			
111.5						3.7		4.4	5.1		4.9	5.1			
118.1									4.4		4.2	4.9			
124.7									3.3			4.6			
131.2												3.7			



ATF 130G-5

Lifting heights / Alturas de elevación

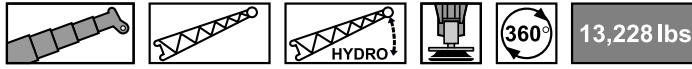

SAE

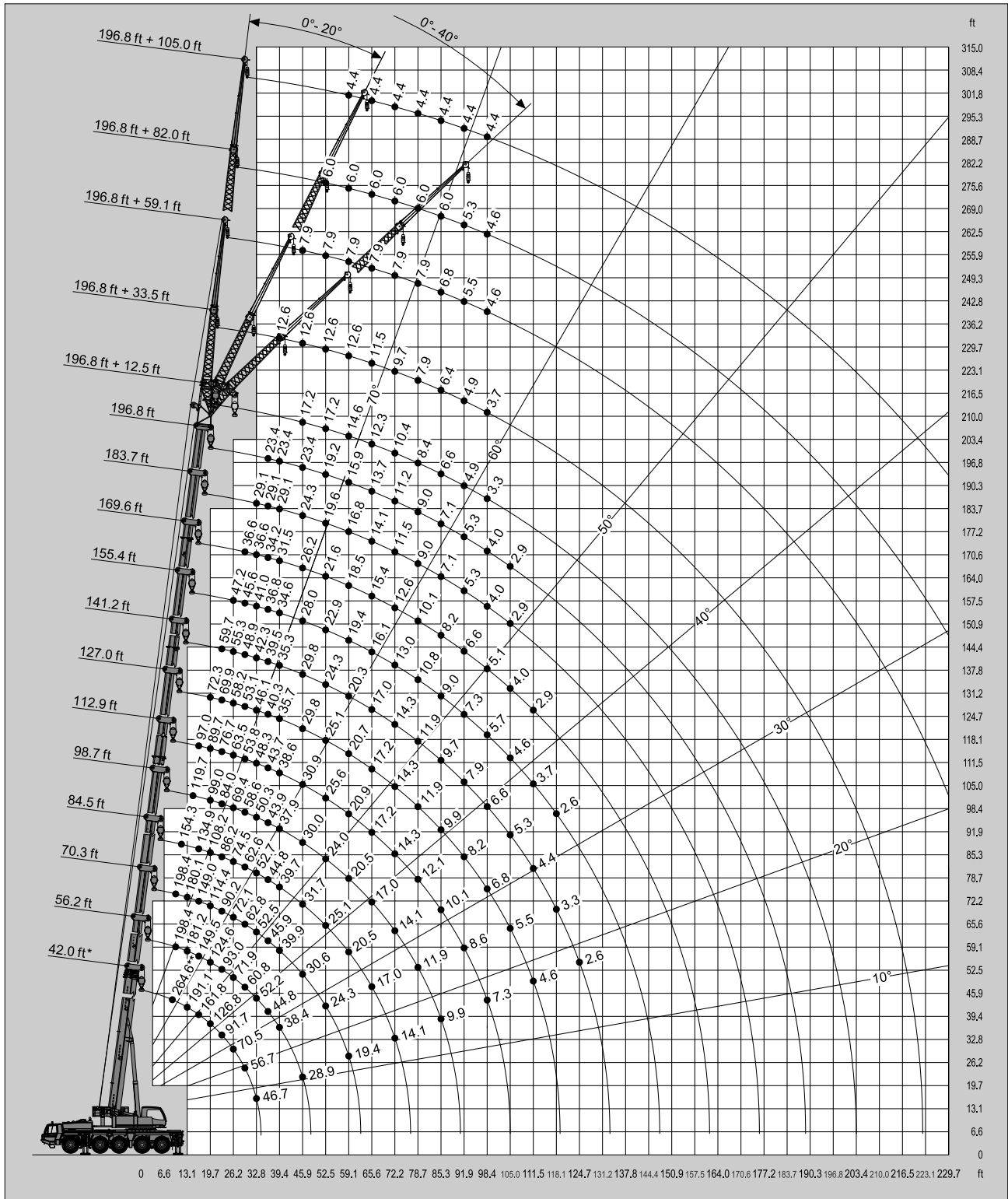

* Over rear / * Sobre la parte trasera
** With additional lifting equipment / ** Con equipo adicional



ATF 130G-5

Lifting capacities / Capacidades de elevación

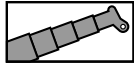

7,275 lbs

SAE

ft	42.0 ft*	42.0 ft	56.2 ft	70.3 ft	84.5 ft	98.7 ft	112.9 ft	127.0 ft	141.2 ft	155.4 ft	169.6 ft	183.7 ft	196.8 ft
8.9	259.0**												
9.8	232.6**	222.7**	198.4	198.4									
11.5	208.3	200.2	198.4	198.4	154.3								
13.1	187.2	179.0	178.8	177.7	154.3								
14.8	170.0	161.4	162.3	159.8	145.9	119.7							
16.4	153.7	146.2	147.3	140.2	124.8	112.0	97.0						
19.7	116.8	116.8	115.5	105.8	99.9	93.5	83.8	72.3					
23.0	84.2	84.2	85.8	81.8	82.2	76.6	69.7	63.3	59.5				
26.2	66.1	66.1	67.2	71.2	67.7	63.1	57.5	56.4	50.9	47.2			
29.5	54.9	54.9	58.6	58.0	56.9	53.1	51.4	48.1	44.1	41.0	36.6		
32.8	45.4	45.0	49.2	50.0	48.5	45.4	45.0	41.7	40.8	37.5	34.8	29.1	
36.1			41.0	43.2	42.3	39.5	39.2	36.4	37.3	34.6	31.5	29.1	23.4
39.4			34.6	36.6	36.6	34.8	34.6	32.8	33.3	31.1	29.1	26.9	23.4
45.9			25.4	27.1	28.7	27.1	29.1	27.8	26.7	24.9	23.4	21.4	20.7
52.5				21.2	22.5	22.5	23.4	22.7	22.3	20.3	19.6	17.9	17.2
59.1				16.8	18.3	18.3	18.7	18.5	18.1	17.1	16.5	14.8	14.3
65.6					14.8	15.0	15.4	15.0	14.8	13.9	13.4	12.1	11.9
72.2					12.1	12.3	12.6	12.3	12.1	11.3	10.6	9.5	9.5
78.7						9.9	10.4	10.1	9.9	9.1	8.6	7.3	7.3
85.3						8.2	8.6	8.2	7.9	7.3	6.6	5.3	5.3
91.9							7.1	6.6	6.6	5.7	5.1	4.0	4.0
98.4							5.7	5.3	5.3	4.4	3.7	2.6	2.6
105.0								4.4	4.2	3.3	2.6		
111.5								3.3	3.1	2.4			

* Over rear / * Sobre la parte trasera / ** With additional lifting equipment / ** Con equipo adicional

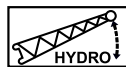
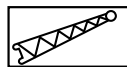
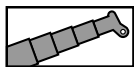

7,275 lbs

SAE

ft	196.8 ft + 12.5 ft			196.8 ft + 33.5 ft			196.8 ft + 59.1 ft			196.8 ft + 82.0 ft			196.8 ft + 105.0 ft		
	0°	20°	40°	0°	20°	40°	0°	20°	40°	0°	20°	40°	0°	20°	40°
39.4				12.6											
45.9	17.2	17.2	17.2	12.6			7.9								
52.5	15.4	16.1	16.3	12.6	12.6		7.9			6.0					
59.1	12.3	12.8	13.4	11.9	12.3		7.9			6.0					
65.6	9.7	10.4	10.8	9.5	11.5	11.0	7.9			6.0					
72.2	7.7	8.2	8.6	7.5	9.3	10.6	7.9	7.3		6.0					
78.7	6.0	6.4	6.8	6.0	7.5	8.8	6.4	7.1		6.0					
85.3	4.4	4.6	5.1	4.4	6.0	7.1	5.1	6.8	5.7	5.1					
91.9		3.3	3.5		4.6	5.7		6.0	5.5						
98.4					3.5	4.4		4.6	5.3						
105.0								3.7	5.3						
111.5									4.2						



ATF 130G-5

Lifting heights / Alturas de elevación

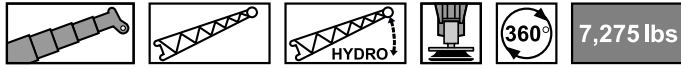

SAE

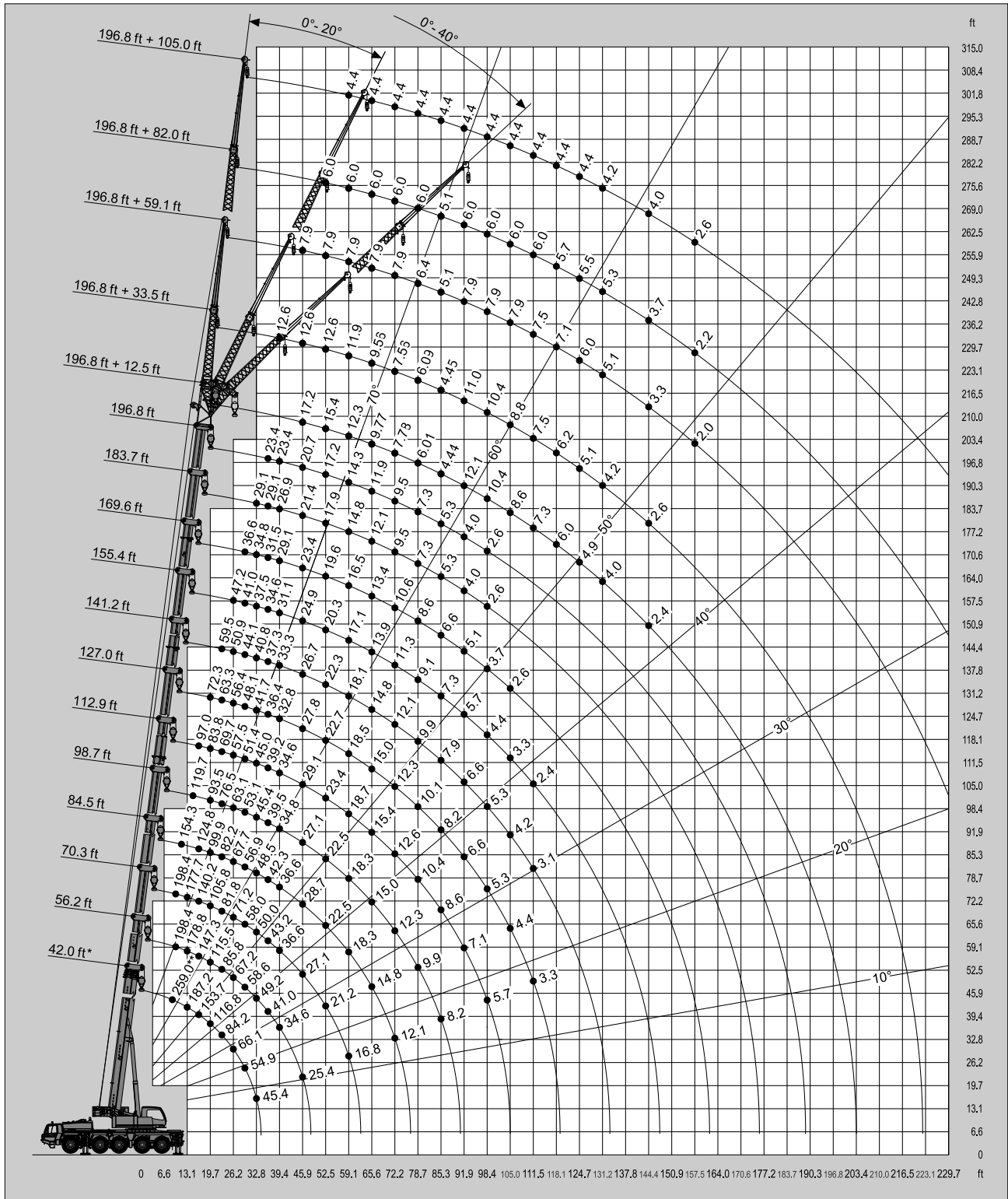

* Over rear / * Sobre la parte trasera
** With additional lifting equipment / ** Con equipo adicional



ATF 130G-5

WARNING AND OPERATING INSTRUCTIONS FOR LIFTING CAPACITIES ATF 220G-5

GENERAL

- Total rated loads shown on the TADANO LOAD RATING CHART apply only to the machine as originally manufactured and normally equipped by TADANO. Modifications to the machine or use of optional equipment other than that specified can result in a reduction of capacity.
- Construction equipment can be dangerous if improperly operated or maintained. Operation and maintenance of this machine must be in compliance with the information in the operation, safety and maintenance manual supplied with the machine. If this manual is missing, order replacement through the distributor.
- The operator and other personnel associated with this machine shall fully acquaint themselves with the latest applicable American National Standards Institute (ANSI) safety standards for cranes.

SET UP

- Total rated loads shown on the TADANO LOAD RATING CHART are the maximum allowable crane capacities and are based on the machine standing level on firm supporting surface under ideal job conditions. Depending on the nature of the supporting surface, it may be necessary to have structural supports under the outrigger floats to spread the load to a larger bearing surface.
- For on outrigger operation, outriggers shall be extended to the dimension according to the TADANO LOAD RATING CHART and secured by pins with tires free of supporting surface, before operating crane.
- Working on tires and travelling with load is not allowed.

OPERATION

- Total rated loads with outriggers fully extended do not exceed 85% of the tipping loads. Total rated loads with outriggers half extended are determined from the formula:
Total rated load = (tipping load - 0.1 tip reaction) / 1.25
- The crane's structural steelwork is in accordance with DIN 15018, part 3. Design and construction of the crane comply with DIN 15018, part 2 and with FEM regulations.
- Total rated loads include the weight of the main hook block, auxiliary hook ball, sling and other auxiliary lifting devices and all their weights shall be subtracted from the listed capacities to obtain the net load to be lifted.

Hook ball / hook block (ton)	11.0	27.6	69.4	88.2	137.8	176.4
Number of sheaves	-	1	3	5	7	9
Weight (lbs)	661	875	1323	1,764	2,646	3,527

Number of rope lines	1	2	3	4	5	6	7	8	9	10	11	12
Max. load capacity (10 ³ lbs)	19.2	37.7	56.4	75.0	93.5	112.0	130.1	148.4	166.4	184.3	202.2	220.0
Number of rope lines	13*	14*	15*	16*	17*	18*						
Max. load capacity (10 ³ lbs)	237.7	255.1	272.5	289.9	307.1	320.0						

* For more than 14 rope lines additional lifting equipment is necessary, see operation manual.

- Total rated loads are based on freely suspended loads and make no allowance for such factors as the effect of wind, sudden stopping of loads, supporting surface conditions, operating speeds, side loads, etc. Side pull on boom or jib is extremely dangerous.
- Total rated loads are taken into account for wind on lifted load or boom as given below. Total rated loads and boom length shall be appropriately reduced, when wind velocity is above 18 mph (26ft/sec.) for long main boom operation and above 15 mph (22 ft/sec.) for jib operation.

Wind speed restrictions for main boom operation	
If the wind speed is	Rated lifting capacities must be reduced to
0 – 18 mph (0 ft/s - 26 ft/s)	no reduction (see load rating charts = 100% normal lifting operation)
19 – 27 mph (27 ft/s - 39 ft/s)	50%
28 mph – 34 mph (40 ft/s - 50 ft/s)	30%
> 34 mph (> 50 ft/s)	Crane operation must be shutdown and boom retracted and lowered to horizontal

- Total rated loads at load radius shall not be exceeded. Do not tip the crane to determine allowable loads.
- Do not operate at boom lengths beyond radii or boom angles where no capacities are shown. Crane may overturn without any load at the hook.
- Slewing of the superstructure is admissible only when the crane is supported on half or fully extended outriggers.
- The lifting capacity ratings specified in the TADANO LOAD RATING CHART apply to the telescopic boom without fly jib fixed in transport position or working position. If the fly jib is secured to the telescopic boom in transport position or working position, the lifting capacities of the telescopic boom are reduced by the values specified below. The weight of the fly jib is detected in terms of a load, and the load moment limiter will shut off earlier.

Position of the fly jib	Load rating reduction for the telescopic boom with mounted fly jib									
	Telescopic boom length (ft)									
	42.0	56.2	70.3	98.7	112.9	127.0	141.2	155.4	169.6	196.8
	Load rating reduction (10 ³ lbs)									
12.5 ft/33.5 ft/59.1 ft fly jib, mounted in transport position	1.15	0.71	0.51	0.33	0.29	0.24	0.15	0.11	0.07	0.02
12.5 ft fly jib, mounted to the boom head	2.18	2.03	1.94	1.81	1.76	1.74	1.74	1.72	1.70	1.68
33.5 ft fly jib, mounted to the boom head	4.06	3.86	3.42	3.06	2.95	2.87	2.82	2.78	2.76	2.71
59.1 ft fly jib, mounted to the boom head	6.61	5.75	5.27	4.50	4.30	4.10	4.03	3.92	3.86	3.77
82.0 ft fly jib, mounted to the boom head	10.47	8.88	7.94	6.50	6.11	5.78	5.62	5.42	5.29	5.11
105.0 ft fly jib, mounted to the boom head	15.10	12.59	11.09	8.80	8.18	7.63	7.39	7.05	6.83	6.59

- When making lifts at a load radius not shown, use the next longer radius to determine allowable capacity.
- Load per part line should not exceed 16,750 lbf for the main winch and for the auxiliary winch.
- Loaded boom angles are approximate. The boom angle before loading should be greater to account for deflection.
- Extension or retraction of the telescopic boom with loads may be attempted within the limits of the TADANO LOAD RATING CHART. The ability to telescope loads is limited by hydraulic pressure, boom angle, boom length, crane maintenance, etc.
- When erecting or stowing the fly jib, be sure to retain it by hand or by other means to prevent its free movement.
- Use the Anti-Two Block (OVERWIND CUTOFF) disable switch when erecting or stowing the fly jib and stowing the hook block. While the switch is pushed, the hoist will not stop, even when an overwind - condition occurs.
- The working radius specified in the TADANO LOAD RATING CHARTS for the fly jib applies only if the telescopic boom is extended according to the TADANO LOAD RATING CHARTS. If one or more elements of the telescopic boom are retracted partially or completely, the specified boom angles will be decisive in determining total rated lifting capacities.
- When lifting a load by using the fly jib (auxiliary hoist) and telescopic boom (main hoist) simultaneously, do the following:
 - Select the correct program for the load moment device in accordance with jib length, jib offset angle, counterweight and outrigger base.
 - Before starting the operation, make sure that the weight of the load is within the total rated load for the fly jib.
- Safe Load Indicator (S.L.I.)
Before working with the telescopic boom or fly jib, make sure that the automatic safe load indicator is working properly. Before lifting the crane driver has to check the load for any lifting cycle. For working with telescopic boom or fly jib the automatic safe load indicator has to set to the correct automatic safe load indicator mode according to the existing crane working condition. The information shown at the automatic safe load indicator display gives permanent information for crane usage to the crane driver.
- Working with Single Top
Operation with the single top is allowed with the main winch and the auxiliary winch. The maximum allowed capacity is limited by the selected S.L.I. code for main boom operation according to existing counterweight and outrigger base at one side and by the single line pull which is limited by hydraulic pressure at the other side.
For operations with the single top mounted, use the TADANO LOAD RATING CHART for the telescopic boom in accordance with existing counterweight and outrigger base to find the total rated lifting capacity and also select the correct S.L.I. code for the telescopic boom in accordance with the existing counterweight and outrigger base. Find the total rated lifting capacity based on boom length and working radius. From that value, subtract 1,100 lbs and the weights of all lifting equipment used including hook block, sling and other auxiliary lifting devices. The result (<total rated lifting capacity> - <1,100 lbs> - <lifting equipment>) is the total rated lifting capacity for a single top lift.

Definitions

- Working Radius: Horizontal distance from a projection of the axis of rotation to supporting surface before loading to the center of the vertical hoist line or tackle with load applied. The deflection of the boom due to its deadweight and the rated load are taken into account.
- Loaded Boom Angle: The angle between the boom base section and the horizontal, after lifting the total rated load at the working radius.
- Working Area: Area measured in a circular arc about the centerline of rotation.
- Freely Suspended Load: Load hanging free with no direct external force applied except by the hoist line.
- Side Load: Horizontal side force applied to the lifted load either on the ground or in the air.

Safe Load Indicator

The Safe Load Indicator is intended as an aid to the operator. Under no condition should it be relied upon to replace use of TADANO LOAD RATING CHARTS and Operating Instructions. Sole reliance upon the Safe Load Indicator Aids in place of good operating practice can cause an accident. The operator must exercise caution to assure safety.



ATF 130G-5

ATF130G-5 Axle weight distribution chart

1) Normal traveling condition

	GVW	Axle 1	Axle 2	Axle 3	Axle 4	Axle 5
Base machine with 20.5 R 25 tires, 10 x 8 drive, no counterweight, 100% fuel, A/C both cabs	113,828	24,114	24,100	21,732	22,034	21,848
Add: A: 6,834 lbs (1.5 metric ton) Counterweight at superstructure : Cwt. # 7	6,822	-2376	-2352	3914	3818	3818
B: 1,984 lbs (1.8 metric ton) Counterweight (1,984 lbs x 2 pcs.) at superstructure : Cwt. # 8 & # 9	3,925	-1585	-1569	2399	2340	2340
C: 3,306 lbs (3.1 metric ton) Counterweight (behind winch- fixed)at superstructure Cwt. # 10	3,270	-1394	-1380	2048	1998	1998
Base machine with 20.5 R 25 tires, 10 x 8 drive, 100% fuel, A/C both cabs + Cwt. # 7, # 8, # 9 & # 10 (14,108 lbs) at superstructure	127,845	18,759	18,799	30,093	30,190	30,004
Base machine with 20.5 R 25 tires, 10 x 8 drive, 100% fuel, A/C both cabs + Cwt. # 7, # 8, # 9 & # 10 (14,108 lbs) at superstructure	126,535	18,546	18,586	29,797	29,896	29,710
Add: 1. 11.0 t (10 metric ton) hook ball in Storage	662	73	72	175	171	171
2. 69.4 t (63.0 metric ton) 3 sheaves single hook block at front	1,322	1289	1273	-419	-409	-409
3. 88.2 t (80.0 metric ton) 5 sheaves dubble hook block at front	1,764	1715	1697	-558	-545	-545
4. 33.5 ft / 59.1 ft fly jib (include brackets)	4,054	2,303	2,280	-179	-175	-175
5. Auxiliary winch with cable	3,241	-1,398	-1,384	2,041	1,991	1,991
6. Additional oil cooler	93	-11	-11	39	38	38
7. Towing attachment	176	-70	-70	107	105	105
8. Tool box at rear	154	-58	-57	91	89	89
9. 16.00 R 25 tyres in lieu of 20.5 R 25 tyres	-1103	-221	-221	-221	-221	-221
1. 5,952 lbs (2.7 metric ton) Counterweight at carrier : Cwt. # 1	5,954	2,054	2,033	633	617	617
2. 7,495 lbs (3.4 metric ton) Counterweight at carrier : Cwt. # 2	7,505	2,598	2,563	797	778	778
3. 19,621 lbs (8.9 metric ton) Counterweight at carrier : Cwt. # 3	19,549	6,744	6,676	2,077	2,026	2,026

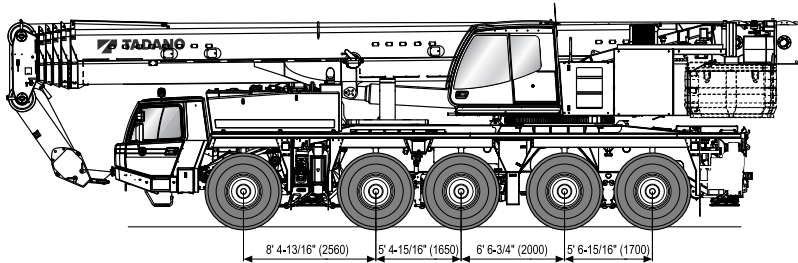

1) Traveling with boom dolly

	GVW	Axle 1	Axle 2	Axle 3	Axle 4	Axle 5	Dolly
Base machine with 20.5 R 25 tires, 10 x 8 drive, no counterweight, 100% fuel, A/C both cabs	119,337	18,790	18,829	18,602	18,981	18,795	
Add: A: 6,834 lbs (1.5 metric ton) Counterweight at superstructure : Cwt. # 7	3,269	1,383	1,369	175	171	171	25,340
B: 1,984 lbs (1.8 metric ton) Counterweight (1,984 lbs x 2 pcs.) at superstructure : Cwt. # 8 & # 9	3,925	1,572	1,557	270	263	263	
C: 3,306 lbs (3.1 metric ton) Counterweight (behind winch- fixed)at superstructure Cwt. # 10	6,822	2,353	2,330	725	707	707	
Base machine with 20.5 R 25 tires, 10 x 8 drive, 100% fuel, A/C both cabs + Cwt. # 7, # 8, # 9 & # 10 (14,108 lbs) at superstructure	133,353	24,098	24,085	19,772	20,122	19,936	
Base machine with 20.5 R 25 tires, 10 x 8 drive, 100% fuel, A/C both cabs + Cwt. # 7, # 8, # 9 & # 10 (14,108 lbs) at superstructure	133,353	24,098	24,085	19,772	20,122	19,936	25,340
Add: 1. 11.0 t (10 metric ton) hook ball in Storage	662	73	72	175	171	171	0
2. 69.4 t (63.0 metric ton) 3 sheaves single hook block at front	1,322	0	0	0	0	0	1,322
3. 88.2 t (80.0 metric ton) 5 sheaves dubble hook block at front	1,746	0	0	0	0	0	1,764
4. 33.5 ft / 59.1 ft fly jib (include brackets)	988	246	243	169	165	165	3,067
5. Auxiliary winch with cable	3,241	1,387	1,373	163	159	159	0
6. Additional oil cooler	93	11	11	24	23	23	0
7. Towing attachment	176	-70	-70	107	105	105	0
8. Tool box at rear	154	-58	-57	91	89	89	0
9. 16.00 R 25 tyres in lieu of 20.5 R 25 tyres	-1103	-221	-221	-221	-221	-221	0
1. 5,952 lbs (2.7 metric ton) Counterweight at carrier : Cwt. # 1	5,954	2,054	2,033	633	617	617	0
2. 7,495 lbs (3.4 metric ton) Counterweight at carrier : Cwt. # 2	7,505	2,598	2,563	797	778	778	0
3. 19,621 lbs (8.9 metric ton) Counterweight at carrier : Cwt. # 3	19,549	6,744	6,676	2,077	2,026	2,026	0

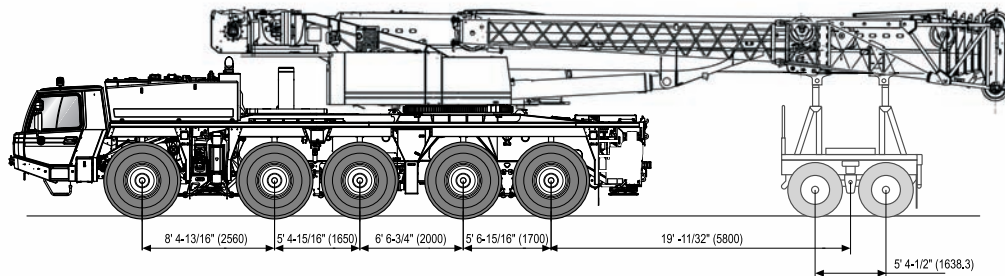



ATF 130G-5

Counterweight versions / Variaciones de contrapeso

	Counterweight / Contrapeso	1x	1x	1x	1x	1x	2x	1x	1x	1x
		①	②	③	④	⑤	⑥	⑦	⑧	⑨
	(t)	1.5	0.9	0.9	3.1	10.0	5.3	8.9	3.4	2.7

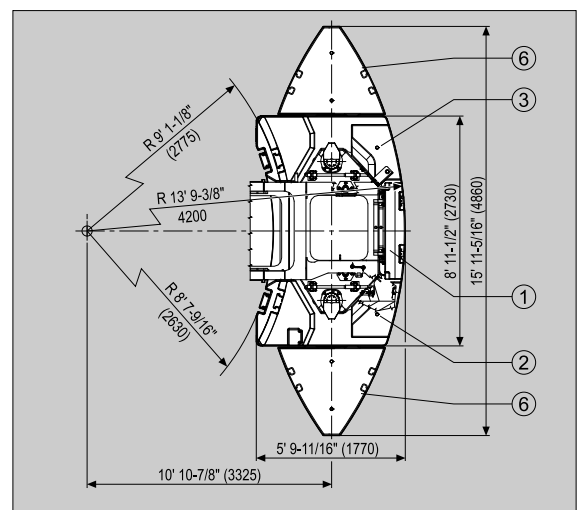
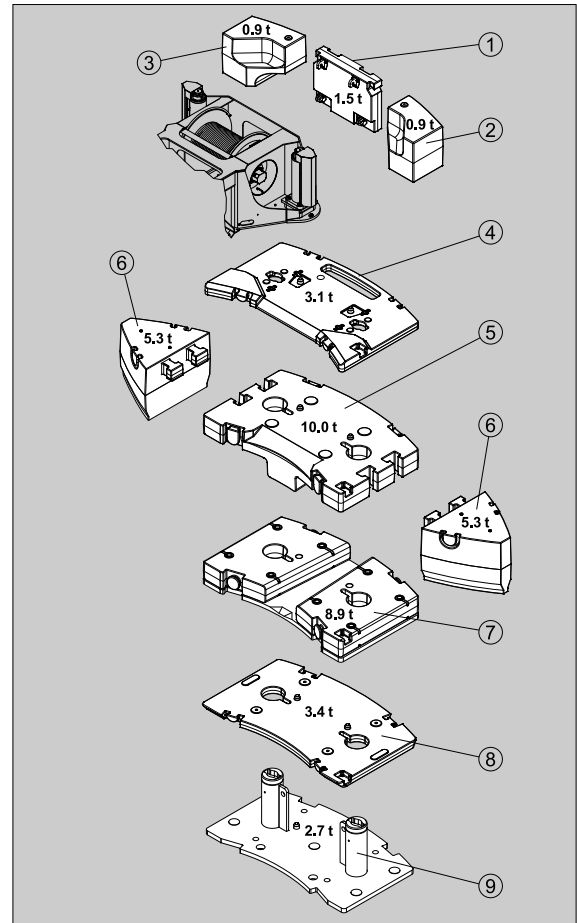
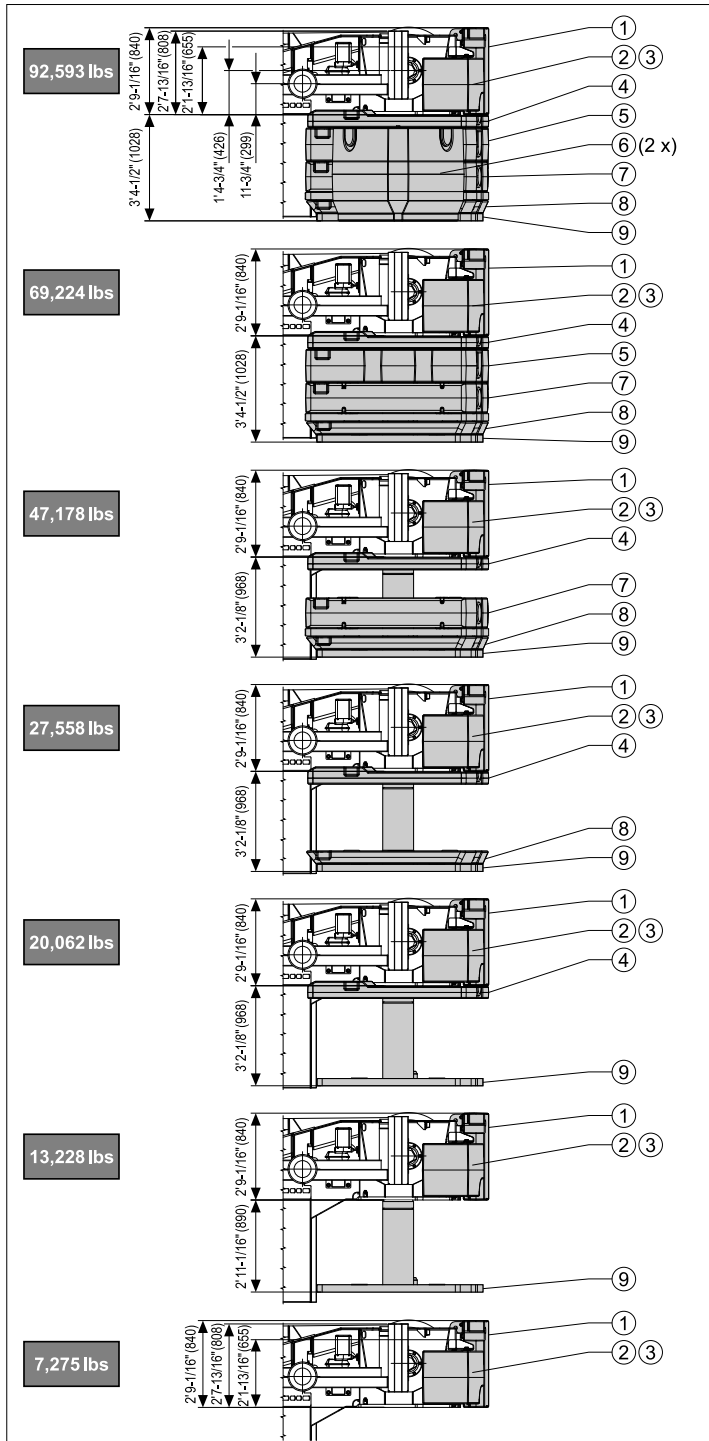



ATF 130G-5

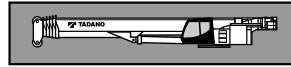
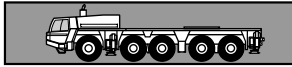

Frame Torsion resistant, welded construction made from high strength, fine-grained steel. Central lubricating system.

Outriggers 4 point, double telescopic hydraulic outriggers with controls on both sides of carrier and in superstructure cab. Outrigger base 7.5 m (5.0 m mid extension) x 8.0 m.

Carrier engine Mercedes-Benz 8 cylinder model OM 502 LA (Euromot III B) water-cooled diesel engine. Rated at 405 kW (551 HP) at 1800 min⁻¹. Torque 2600 Nm (265 kpm) at 1300 min⁻¹. Engine rating according to 80 / 1269 / EWG. Fuel tank 132 gal (500 l). AdBlue-tank: 11 gal (40 l).

Transmission ZF-AS-Tronic 12 AS 2302 mechanical transmission with integrated interarder, electro-pneumatically operated dry-type clutch and automatic gear shifting with 12 forward gears and 2 reverse gears. Power / Economy mode.

Transfer Case Two stage.

Drive 10 x 6 (10 x 8 option).

Axles

- 1st axle: steered, not driven.
- 2nd axle: steered, driven, with transverse differential lock.
- 3rd axle: steered, not driven.
- 4th axle: steered, driven, with transverse and longitudinal differential lock.
- 5th axle: steered, driven, with transverse differential lock.

Suspension Hydro-pneumatic with levelling adjustment.

Brake system Service disc brakes: dual circuit compressed air system with electrically wear control and air dryer. Parking brake: spring loaded type acting on 3rd, 4th and 5th axles. Auxiliary brakes: Intarder / Bremsomat function, engine exhaust brake and constant throttle engine brake system.

Tyres (10) 445/95 R 25 (16.00 R 25), width 9' 1/4" (2.75 m).

Steering system ZF-Servocom, dual circuit hydraulic steering with emergency steering pump, mechanical hydraulically-assisted steering of the first and second axle and automatic steering of the 3rd and 4th axle up to a travel speed of 15.5 mph (25 km/h) and of the 5th axle up to 31.1 mph (50 km/h).

Carrier cab Two man full width cab of composite (steel sheet metal and fibre-glass) structure, with safety glass, air-cushioned adjustable seats, driver seat with seat heater, engine dependent hot-water heater. Complete controls and instrumentation for road travel. Speed control.

Electrical system 24 volt DC system, 2 batteries, CAN-Bus system with Faun CSS integrated self-diagnosis system, outrigger area lighting. Electrical system conforms with EEC regulations.

Optional Equipment (at extra charge)

Towing attachment, engine independent additional heater with engine pre-heat, air conditioning, ABS, 525/80 R 25 (20.5 R 25) tyres, spare wheel, special painting and lettering.

Further optional equipment available upon request.

Frame Torsion-resistant, all-welded structure of high strength steel. Connected to carrier by single-row ball-bearing slewing ring with external gearing for 360° continuous rotation. Central lubricating system.

Superstructure engine Mercedes-Benz 4 cylinder model OM 924 LA (Euromot III B), water cooled, diesel engine. RPM infinitely variable via foot pedal, rating 127 kW (173 HP) at 2000 min⁻¹. Torque 675 Nm (69 kpm) at 1200 - 1600 min⁻¹. Engine rating according to 80 / 1269 / EWG. Fuel tank 58 gal (220 l). AdBlue-tank: 2 gal (8 l).

Hydraulic system Three circuit diesel hydraulic system with 1 power controlled double axial piston pump (electrically adjustable), 1 axial piston pump and 2 gear pumps, oil cooler.

Controls Electrical, 2 joy-stick levers for simultaneous operation of crane motions.

Telescopic boom 6 sections, made of high tensile, fine-grained steel, consisting of 1 base section and 5 telescoping sections extended by means of a single telescopic cylinder. All telescope sections extendable under partial load. 12.8 m to 60.0 m long.

Derricking system 1 double acting hydraulic cylinder with integral brake and holding valve, Slow-Stop-function.

Main winch Axial piston motor, winch drum with integrated planetary reduction and with hydraulically controlled spring-loaded, multiple disc brake and with integrated free rotation (no sagging of load when hoisting). Hoist cable with 'Super-Stop' easy reeving system.

Slewing system Axial piston motor with three-stage planetary gear with a foot actuated or automatic service and a parking brake. Open circuit with free slewing function. Speed infinitely variable 0 - 1.6 min⁻¹.

Counterweight Standard 42 t divisible, assembled and disassembled by hydraulic cylinders controlled from superstructure cab.

Superstructure cab Spacious panoramic cab of composite structure with safety (tinted) glass windows, tiltable cockpit with hydraulically cushioned adjustable seat, seat heater, engine independent hot-water heater. Complete controls and instrumentation for crane operation. Outrigger and engine controls from the superstructure.

Electrical system 24 volt DC system, 2 batteries.

Safety devices 'Lift Adjuster', load moment device (LMD), working area limiter, hoist limit switch, lower limit switch and drum turn indicator, Slow-Stop-function for slewing system and derricking system, safety valves against pipe and hose rupture, holding valves on hydraulic cylinders.

Optional Equipment (at extra charge)

Boom extension 3.8 m / 10.2 m / 18.0 m / 25.0 m / 32.0 m, offsets 0°, 20° and 40° or hydraulically 0°- 40°, LMD-programme for 12.5 t and 21.4 t counterweight, 10 t swivel hook, selection of hook blocks 25 t - 125 t, auxiliary winch, engine independent additional heater with engine pre-heat, additional oil cooler, air conditioning, special painting and lettering, outrigger load display.

Further optional equipment available upon request.

TADANO FAUN ATF 130G-5

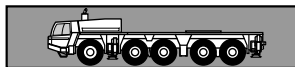

Chasis portante Construcción de acero de alta resistencia soldado, resistente a la torsión y a la flexión. Sistema de engrase central.

Estabilizadores Estabilizadores hidráulicos de 4 puntos. Posibilidad de manejo desde ambos lados del chasis portante y desde la cabina de la grúa. Extensión de los estabilizadores: 7,5 m (y 5,0 m) x 8,0 m.

Motor Mercedes Benz modelo OM 502 LA (Euromot III B), 8 cilindros, diesel, refrigerado por agua. Nominal 405 kW (551 HP) a 1800 min⁻¹. Par 2600 Nm (265 kpm) a 1300 min⁻¹. Potencia del motor según 80/1269/EWG. Depósito de combustible de 500 l. Depósito AdBlue 40 l.

Transmisión Transmisión mecánica tipo ZF-AS Tronic modelo 12 AS 2302 con intarder integrado, accionamiento electro - neumático embrague en seco y cambio automático, 12 marchas delanteras y 2 marchas traseras. Modo rendimiento máximo / económico.

Transmisión Caja de distribución (transfer) con 2 relaciones de velocidad.

Tracción 10 x 6 (10 x 8 opción).

Ejes

- 1º eje: de dirección, no accionado.
- 2º eje: de dirección, accionado, con bloqueo diferencial transversal.
- 3º eje: de dirección, no accionado.
- 4º eje: de dirección, accionado, con bloqueo diferencial transversal y longitudinal.
- 5º eje: de dirección, accionado, con bloqueo diferencial transversal.

Suspensión Suspensión hidroneumática con regulación de nivel.

Sistema de frenos Accionamiento neumático de doble circuito con indicador eléctrico de desgaste de freno y secador de aire. Freno de estacionamiento del tipo muelles cargados, liberados por aire, sobre los ejes 3º, 4º y 5º. Intarder / sistema automático de frenado y freno continuo: Freno de motor diesel en el escape.

Neumáticos 10 x 445/95 R 25 (16.00 R 25), (ancho 2,75 m).

Dirección Hidráulica ZF Servocom de doble circuito con bomba auxiliar de dirección. Dirección mecánica del 1º y 2º eje y direccionable del 3º y 4º eje hasta una velocidad de 25 km/h y del 5º eje hasta una velocidad de conducción de 50 km/h.

Cabina Cabina para dos personas, en construcción de acero y fibra de vidrio. Cristales de seguridad, asiento con suspensión neumática, asiento de conductor calefactado, calefacción dependiente caliente del motor. Elementos de control y manejo para circular por carretera. Regulador de velocidad.

Sistema eléctrico Sistema de 24 V c.c. con 2 baterías, conexiones eléctricas integradas en el sistema CAN-Bus, sistema integrado de diagnóstico Faun-CSS. Focos de iluminación en el área de trabajo de los estabilizadores (gatos). El sistema eléctrico cumple la normativa CEE.

Equipo adicional (con suplemento de precio)
Embrague de remolque, calefacción adicional con pre-calefacción de motor, climatización, ABS, neumáticos 525/80 R 25 (20.5 R 25), rueda de repuesto, pintura especial y rotulación. Otros equipamientos sobre pedido.

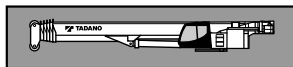

Superestructura Construida en aceros soldados, resistente a la torsión. Corona de giro con rodamiento de una fila de bolas con dientes externos para giro continuo a 360°. Sistema de engrase central.

Motor Mercedes Benz modelo OM 924 LA (Euromot III B), 4 cilindros, diesel, refrigerado por agua. Las revoluciones aumentan de forma gradual accionado el acelerador. Nominal 127 kW (173 HP) a 2000 min⁻¹. Par 675 Nm (69 kpm) a 1200 - 1600 min⁻¹. Potencia del motor según 80/1269/EWG. Depósito de combustible de 220 l. Depósito AdBlue 8 l.

Sistema hidráulico Sistema hidráulico de 3 circuitos, 1 bomba doble de pistones axiales de caudal variable (regulable eléctricamente) una bomba de pistones axiales y 2 bombas en tandem, enfriador de aceite.

Mandos 2 palancas de control de tipo joy-stick para movimientos simultáneos de la grúa (4 direcciones), asistidos eléctricamente.

Pluma telescópica 6 secciones, un tramo base y 5 telescópicos de acero de alta resistencia soldado, 1 cilindro hidráulico, los tramos se pueden telescopar hidráulicamente bajo carga. Longitud de 12,8 m a 60,0 m.

Elevación de pluma Mediante un cilindro hidráulico de doble efecto con válvula de retención integrada, funciones 'Slow-Stop'.

Cabrestante principal Motor hidráulico de pistones axiales y caudal fijo. Tambor del cabrestante con reducción planetaria y frenos de disco múltiples accionado, con sistema libre de elevación. Cable de elevación con sistema fácil de guiado y 'Super-Stop'.

Sistema de giro Motor hidráulico de pistones axiales con reducción planetaria de tres etapas. Freno de giro controlado por pedal y freno de giro automático de bloqueo. Circuito abierto con mecanismo de giro libre con posibilidad de desconexión. Velocidad de giro gradual de 0 a 1,6 min⁻¹.

Contrapeso El estándar 42 t divisible, se acciona desde la cabina de la grúa.

Cabina de la grúa Cabina espaciosa y confortable, en construcción de acero y fibra de vidrio, con cristales tintados de seguridad. Asiento del operador regulable amortiguado hidráulicamente, inclinable junto con los instrumentos y mandos, asiento calefactado, calefacción independiente caliente del motor. Elementos de control y mando para el manejo de la grúa. Accionamiento de los estabilizadores y motor desde la superestructura.

Sistema eléctrico Sistema de 24 V c.c. con 2 baterías.

Medidas de seguridad 'Lift Adjuster', limitación del momento de carga (LMC), limitación del área de trabajo, interruptor de final de elevación, interruptor de 3 últimas vueltas en cabrestante, indicador de bajada o subida del cable del cabrestante, para las funciones 'Slow-Stop' de giro y abatimiento, válvulas de seguridad para rotura de tubos y latiguillos. Válvulas de retención en los cilindros hidráulicos.

Equipo adicional (con suplemento de precio)
Plumín de 3,8 m / 10,2 m / 18,0 m / 25,0 m / 32,0 m regulable de 0°, 20° y 40° (o hidráulicamente 0° a 40°), prolongación, programación LMC en el sistema de limitación de cargas, para contrapesos de 12,5 t y 21,4 t, 10 t gancho de bola, gancho de 25 a 125 t, 2º cabrestante, calefacción adicional con pre-calefacción de motor, enfriador adicional, climatización, pintura especial y rotulación, control carga (gatos de apoyo). Otros equipamientos sobre pedido.



ATF 130G-5

Symbols / Glosario de simbolos

	As on Page 30 Véase la pagina 30		Counterweight versions Variaciones de contrapeso
	Outriggers Estabilizadores		Telescopic boom Pluma telescópica
	Transmission / Gear Transmisión / Marchas		Boom telescoping Telescopaje de pluma
	Axle load Carga por eje		Derricking system Elevación de pluma
445/95 (16.00)	Tyres / Size Neumáticos / Tamaño de ruedas		Radius Radio
	Off road Todo terreno		Boom extension Plumín
	On road En carretera		Boom extension hydraulically Plumín hidráulicamente
	Speeds Velocidades		Radius Radio
	Gradeability Superacion de pendientes		Main winch Cabrestante principal
	Slewing system Sistema de giro		Auxiliary winch 2º cabrestante
92,593 lbs	Counterweight Contrapeso		Hook block / Swivel hook Gancho / Gancho de bola