

90T 8690

90-ton (81.65 mt) Hydraulic Truck Crane

- 90 tons (81.65 mt) at 8 ft (2.44 m) radius
- 38-140 ft (11.6-42.7 m) five section, full power latching boom with no charted capacity deductions for telescoping loads
- 35-58 ft (10.7-17.7 m) two-piece, bi-fold, on-board lattice attachment with 2°, 15°, 30°, and 45° offsets - optional
- Two 16 ft (4.9 m) lattice inserts provide a total attachment length of 90 ft (27.4 m) - optional
- 237 ft (72.2 m) maximum tip height
- Modular style counterweights
- 16,880 lbs (7 656.6 kg) maximum winch line pull
- 480 fpm (146.3 m/min) maximum winch line speed
- Next generation operator's cab with improved visibility and ergonomics
- 445 hp (331.8 kW) Detroit Diesel engine with 1,450 ft-lbs (1966 J) of torque
- ZF AS Tronic 12 speed automated manual transmission
- 62.3 mph (100.3 km/hr) travel speed
- Front and rear air ride suspension
- Anti-lock (ABS) brakes
- Four lockable storage boxes available
- "Stow 'n Go" steel pontoons

Link-Belt
CRANES

HTC 8690

90-ton (81.65 mt) Hydraulic Truck Crane

HTT 8690

90-ton (81.65 mt) Truck Terrain Crane



The HTT's all-wheel steer provides outstanding on-site mobility.

- 90 tons (81.65 mt) at 8 ft (2.44 m) radius
- 38-140 ft (11.6-42.7 m) five section, full power latching boom with no charted capacity deductions for telescoping loads
- 35-58 ft (10.7-17.7 m) two-piece, bi-fold, on-board lattice attachment with 2°, 15°, 30°, and 45° offsets - optional
- Two 16 ft (4.9 m) lattice inserts provide a total attachment length of 90 ft (27.4 m) - optional
- 237 ft (72.2 m) maximum tip height
- Modular style counterweights
- 16,880 lbs (7 656.6 kg) maximum winch line pull
- 480 fpm (146.3 m/min) maximum winch line speed
- Next generation operator's cab with improved visibility and ergonomics
- Automated Manual Transmission
- Front and rear air ride suspension
- Anti-lock (ABS) brakes
- Four lockable storage boxes available
- "Stow 'n Go" steel pontoons

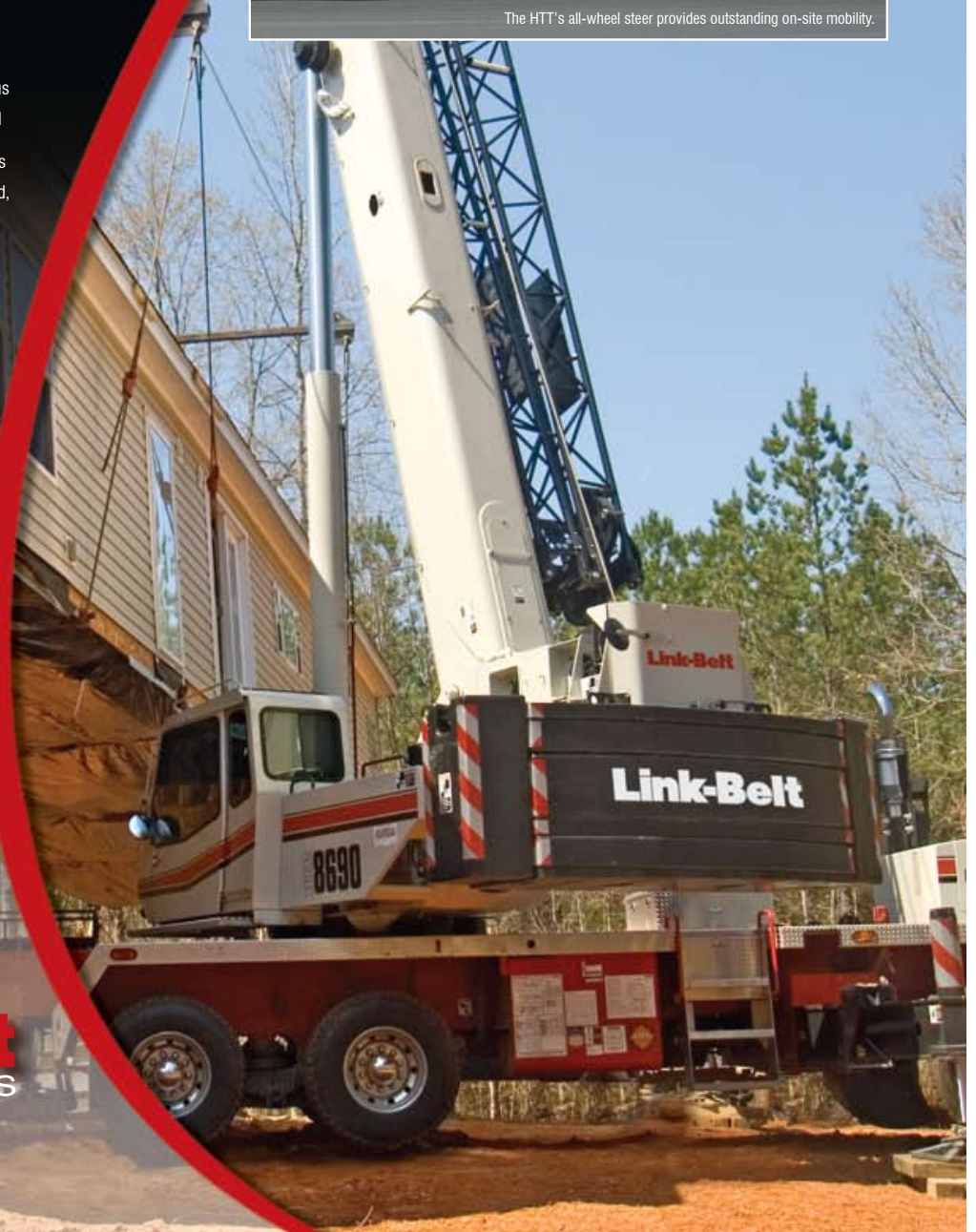

Link-Belt
CRANES

HTC 8690

90-ton (81.65 mt) Hydraulic Truck Crane

HTT 8690

90-ton (81.65 mt) Truck Terrain Crane

- 5-section full power latching boom with attachment flexibility
- Big, wide cab with outstanding visibility
- Winches deliver impressive numbers of line pull and line speed
- Counterweight flexibility, big engine and transmission power, along with air ride promise incredible mobility on the road or on the job

☐ All counterweight configurations can be raised and lowered by hydraulic cylinders from the comfort of the operator's cab for ease of installation and removal.



Comfortable carrier :

- Dash-mounted comprehensive instrumentation with backlit gauges
- Sliding side and rear windows and roll up/down door window provides excellent ventilation
- Fully adjustable air-ride fabric seat
- Suspended pedals

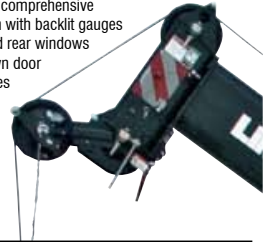

35-58 ft (10.7-17.7 m) two-piece bi-fold lattice attachment with 2°, 15°, 30° and 45° offsets



Outstanding mobility on the road and on the job site

- Cruise control
- Three stage engine compression brake
- Ether injection system – optional
- Automated transmission (no clutch pedal) — 12 speeds forward, 2 speeds reverse with two modes of operation: fully automatic and semi-automatic
- Job site travel is permissible with all 39,500 lbs (17 917.2 kg) of counterweight for exceptional job site versatility:
 - HTC: 1.3 mph (2.1 km) job site travel
 - HTT: 1.2 mph (1.9 km) job site travel
- Highway speeds unmatched in the industry today:
 - HTC: up to 62.3 mph (100.3 km/hr)
 - HTT: up to 56.1 mph (90.2 km/hr)



- ☐ **Boom dolly/trailer ready** when equipped with optional boom float kit and rear electrical and air connections
- ☐ **Optional rear electrical and air connections**



- ☐ **Raydan™ air-ride suspension** front and rear provides a smooth ride and precise handling. Optional air-ride lift system holds the rear suspension retracted while the crane is on outriggers.

- ☐ There are two standard **locking storage boxes** with options for up to four boxes.



For Rental Inquiries Please Call (800) 335-3148 Or Visit Us On The Web At Southwaycrane.com

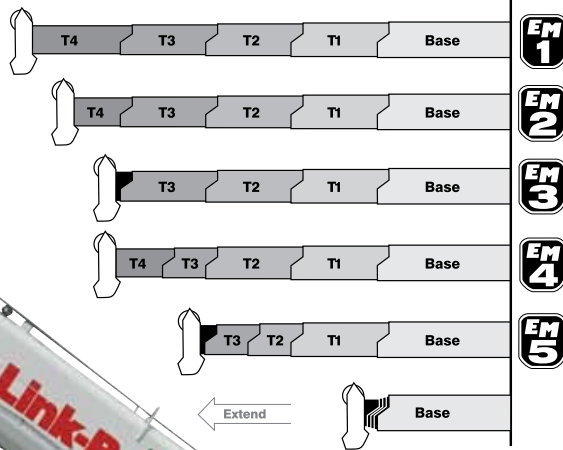

5-section full power latching boom with attachment flexibility

- 38-140 ft (11.6-42.7 m) latching boom with five boom modes for superior capacities throughout the extension range
- No charted capacity reductions for telescoping loads
- Boom requires no greasing because of ingenious Teflon rear pucks impregnated in the full contact wear pads
- No minimum boom angle for extending or retracting the boom sections
- 35-58 ft (10.7-17.7 m) two-piece, bi-fold, on board lattice attachment with 2°, 15°, 30°, and 45° offsets
- Two 16 ft (4.9 m) lattice inserts provide a total attachment length of 90 ft (27.4 m)
- 237 ft (72.2 m) maximum tip height

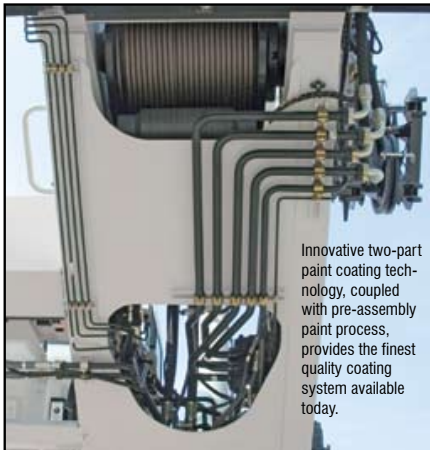

Innovative two-part paint coating technology, coupled with pre-assembly paint process, provides the finest quality coating system available today.

Mechanical boom angle indicator - standard

Optional integrated air conditioning

Folding viewing mirror for travel

Pull-out CabWalk™ slides out from secured travel position underneath operator's cab

Optional hoist drum cable follower and optional third wrap indicators

Winch viewing mirror

Standard 11,500 lbs (5 216 kg) counterweight

Stow 'n Go outrigger pontoons

Carrier-mounted outrigger controls located on each side of carrier, include an engine throttle-up switch for fast outrigger deployment. For fine level adjusting of the carrier, throttle can be taken down to idle.

Large engine doors allow for easy access

Non-slip surface strips on carrier deck

Optional daytime running lights

Self-storing fifth outrigger pontoon

Large west coast-style rear viewing mirrors

Integrated air conditioning (not a roof-mounted system)

Full air, S-cam anti-lock (ABS) brakes

Aluminum wheels and radial tires

Powerful and responsive hydraulics

- Six pump, pressure compensated hydraulic system allows simultaneous and precise function of boom hoist, winch, and swing.
- Two-speed hydraulic piston motor hoist system delivers superior hoisting. Matched size optional front and rear winches provide equal max line pulls of 16,880 lbs (7 657 kg) and max line speeds of 480 fpm (143 m/min) on 16" (41 m) root diameter grooved drums.
- Drum rotation indicators - standard.
- Bi-directional hydraulic swing motor mounted to a planetary reduction unit for 360° continuous smooth swing. Spring applied hydraulic released 360° swing park brake provides infinite swing park positions as well as free swing when control is in neutral position.

CALC — Outrigger beams have three different stages (retracted, intermediate, and fully extended) providing lifting capacities in confined areas.



For Rental Inquiries Please Call (800) 335-3148 Or Visit Us On The Web At Southwaycrane.com



Steerable all wheel axles, in conjunction with super single tires, makes the HTT even harder to beat on the job-site. And NO changes to the on-outrigger capacity charts.

- Drive and steer capabilities for the rear axles
- Four steering modes:
 - Independent front
 - Independent rear
 - Combination
 - Crab
- Rear axles self-center and lock in the straight ahead position for high speed travel.
- Turning radius under 29 ft (8.8 m) at the edge of the tire
- 445/65R22.5 tires front and rear that are interchangeable
- Only one spare rim and tire combination is needed.
- Transverse (cross-axle) differential locks that greatly improve traction on unimproved job-site conditions.

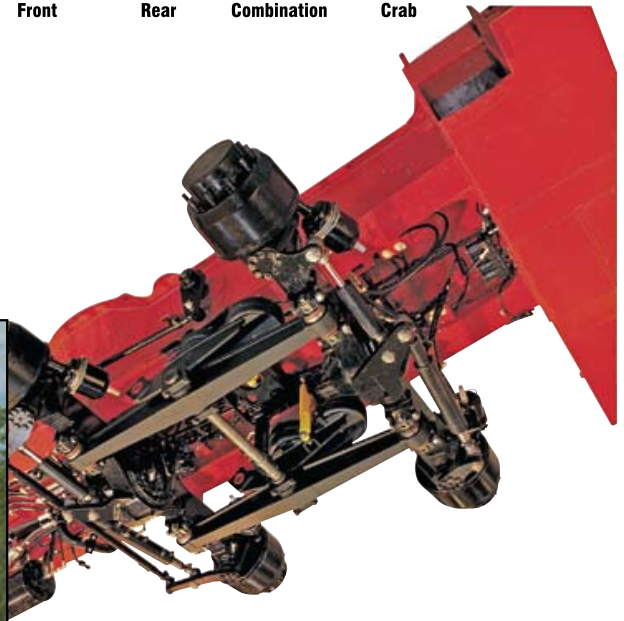
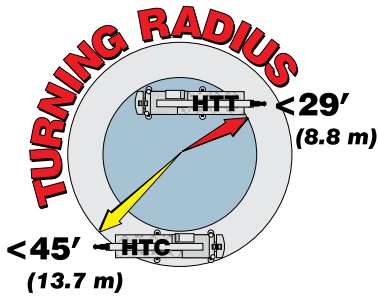
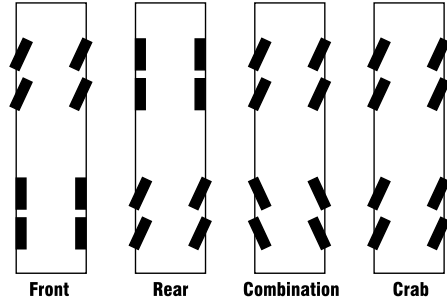

For Rental Inquiries Please Call (800) 335-3148 Or Visit Us On The Web At Southwaycrane.com



Access to the engine compartments and the operator's cab is superb with strategically-located ladders and steps.

Roomier and quieter operator's cab

- Extra large front window almost seamlessly merges into the roof window
- Sliding left side door, right and rear windows, and swing up top window provide excellent ventilation
- All gauges, switches, indicators, and controls are placed in the operators forward line of sight for excellent ergonomics
- All gauges and switches are backlit for excellent visibility when the cab working lights are switched to the on position
- Available — Integrated air conditioning utilizes the same ventilation outlets as the standard heating system



Integrated Microguard rated capacity limiter with color graphic display, for excellent contrast even in direct sunlight, aids the operator in safe and efficient operation by continuously monitoring a multitude of crane conditions. Optional external and internal light bars inform the operator and/or ground crew of the percentage of capacity.



Multiple counterweight configurations give you capacities for any size job

- Standard – Total of 11,500 lbs (5 216 kg) of removable counterweights. Capacities for five different counterweight configurations.
- Optional – Up to 39,500 lbs (17 917.2 kg) of removable counterweights. Capacities for up to thirteen different counterweight configurations.
- All configurations can be raised and lowered by hydraulic cylinders from the comfort of the operator's cab for ease of installation and removal.

Your crane investment is always protected ... with your Link-Belt distributor.

When you invest in a Link-Belt crane, you invest in a legacy of outstanding customer support dating back to 1874. The ultimate value of a machine begins with state-of-the-art design and quality manufacturing, but it is the excellent Link-Belt distributor product support that determines its long term value. This philosophy has earned Link-Belt cranes the enviable position of traditionally commanding some of the highest resale prices in the industry.

... to be recognized as a
leader
in
customer service & satisfaction.
— The Link-Belt Vision

Link-Belt
Preferred

As a member of Link-Belt Cranes user's group, you will have access to:

- Online access to a comprehensive library of all parts, service and operator manuals for YOUR crane
- Interactive, live groundbearing calculations for YOUR crane
- Plus a vast array of information on new products, services and special offerings



Link-Belt headquarters - Lexington, Kentucky

Master Technician TRAINING PROGRAM

Link-Belt's investment in the highly acclaimed Master Technician Training Program is further testimony to its commitment to highly trained, experienced service personnel.

Technical schools are specifically designed to establish proficiency in three phases: fundamentals, machine systems, and diagnostics/repair. To further support these highly trained distributor personnel, Link-Belt has dedicated, full time factory technical advisors available with comprehensive machine records, drawings and technical publications to quickly isolate and resolve service issues.

Link-Belt Construction Equipment Company is a leader in the design, manufacture and sales of telescopic and lattice boom cranes, with headquarters in Lexington, Kentucky.

In the recent decade, a dynamic and highly focused Link-Belt has emerged as a market leader in crane design and product quality standards by focusing on continuous improvement and employee empowerment.

Link-Belt's core production base and center for worldwide operations is its 500,000 sq. ft. (46 451.5 m²) manufacturing facility in Lexington, Kentucky.

With major expansions over the last ten years, along with continuous improvement philosophies, this facility has emerged as the most modern crane facility in North America.



No one knows your Link-Belt crane better than our trained technical specialists and coupled with the energy of our customer parts representatives, no one in the crane industry provides faster, more efficient customer service.

With state of the art computer information systems, distributors order Genuine Link-Belt Parts 24 hours a day, 7 days a week.

Our dedicated 72,000 sq. ft. (6 689 m²) Parts Distribution Center is an integral part of our product support commitment where we invest in an extensive and well planned parts inventory. And all parts in stock ship the same business day.

Link-Belt
CRANES

LINK-BELT CONSTRUCTION EQUIPMENT COMPANY

Lexington, Kentucky | www.linkbelt.com

© Link-Belt is a registered trademark. Copyright 2007. All rights reserved.

We are constantly improving our products and therefore reserve the right to change designs and specifications.

Litho in U.S.A. 11/07 #4344 (supersedes #4331)



Link-Belt Parts Distribution Center

Technical Data

Specifications & Capacities

HTC 8690

Telescopic Boom Truck Crane
90 ton (81.6 metric ton)

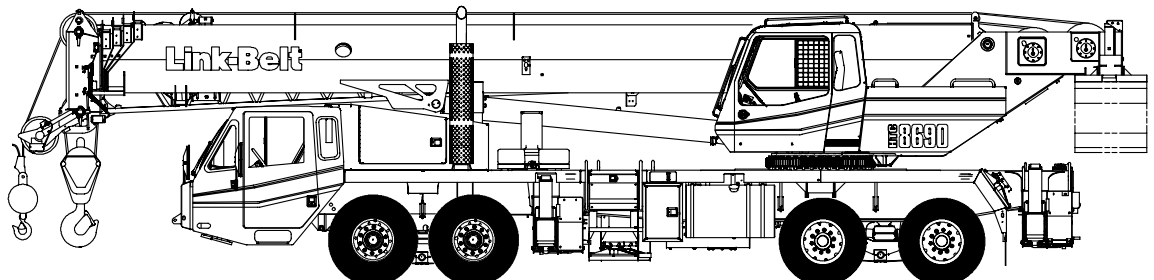

CAUTION: This material is supplied for reference use only. Operator must refer to in-cab Crane Rating Manual and Operator's Manual to determine allowable crane lifting capacities and assembly and operating procedures.



For Rental Inquiries Please Call (800) 335-3148 Or Visit Us On The Web At Southwaycrane.com

5460 (supersedes 5424)–0506–N3

HTC-8690

Link-Belt Cranes

This material is for informational purposes only and is not intended to be a substitute for an operation manual. Only persons that are trained in the operation of heavy machinery should do so. For inquiries, call Southway Crane & Rigging, LLC at (800) 335-3148.



For Rental Inquiries Please Call (800) 335-3148 Or Visit Us On The Web At Southwaycrane.com

5460 (supersedes 5424) – 0506 – N3

Table Of Contents

Boom, Attachments, and Upper Structure	1
Boom	1
Boom Wear Pads	1
Boom Head	1
Boom Elevation	1
Auxiliary Lifting Sheave – Optional	1
Hook Blocks and Balls – Optional	1
Fly – Optional	1
Fly Extensions – Optional	1
Upper Operator’s Cab and Controls	2
Swing	3
Electrical	3
Additional Equipment	3
Load Hoist System	3
Load Hoist Performance	3
2M Main and Optional Auxiliary Winches	3
Hydraulic System	4
Counterweight	4
Carrier	6
General	6
Outriggers	6
Steering and Axles	6
Suspension	6
Tires and Wheels	6
Brakes	6
Electrical	6
Engine	6
Transmission	6
Carrier Speeds and Gradeability	7
Fuel Tank	7
Hydraulic System	7
Pump Drive	7
Lower Cab and Controls	8
Additional Equipment	8
Axle Loads	9
Axle Loads with 2–Axle or 3–Axle Boom Dolly	10
General Dimensions	11
Working Range Diagram	12
Boom Extend Modes	13
Main Boom Lift Capacity Charts – Standard	14
8,500 lb Counterweight – Fully Extended Outriggers – 360° Rotation	14
8,500 lb Counterweight – On Tires – Stationary – Boom Centered Over Rear	15
8,500 lb Counterweight – On Tires – Pick & Carry (1 mph) – Boom Centered Over Rear	15
11,500 lb Counterweight – Fully Extended Outriggers – 360° Rotation	16
11,500 lb Counterweight – On Tires – Stationary – Boom Centered Over Rear	17
11,500 lb Counterweight – On Tires – Pick & Carry (1 mph) – Boom Centered Over Rear	17



For Rental Inquiries Please Call (800) 335-3148 Or Visit Us On The Web At Southwaycrane.com

5460 (supersedes 5424)–0506–N3

Main Boom Lift Capacity Charts – Optional	18
32,500 lb Counterweight – Fully Extended Outriggers – 360° Rotation	18
32,500 lb Counterweight – On Tires – Stationary – Boom Centered Over Rear	19
32,500 lb Counterweight – On Tires – Pick & Carry (1 mph) – Boom Centered Over Rear	19
39,500 lb Counterweight – Fully Extended Outriggers – 360° Rotation	20
Fly Attachment Lift Capacity Charts – Optional	21
8,500 lb Counterweight – Fully Extended Outriggers – 360° Rotation	21
140 ft Main Boom Length – 2° Fly Offset	21
140 ft Main Boom Length – 15° Fly Offset	21
140 ft Main Boom Length – 30° Fly Offset	22
140 ft Main Boom Length – 45° Fly Offset	22
11,500 lb Counterweight – Fully Extended Outriggers – 360° Rotation	23
140 ft Main Boom Length – 2° Fly Offset	23
140 ft Main Boom Length – 15° Fly Offset	23
140 ft Main Boom Length – 30° Fly Offset	24
140 ft Main Boom Length – 45° Fly Offset	24
32,500 lb Counterweight – Fully Extended Outriggers – 360° Rotation	25
140 ft Main Boom Length – 2° Fly Offset	25
140 ft Main Boom Length – 15° Fly Offset	25
140 ft Main Boom Length – 30° Fly Offset	26
140 ft Main Boom Length – 45° Fly Offset	26
39,500 lb Counterweight – Fully Extended Outriggers – 360° Rotation	27
140 ft Main Boom Length – 2° Fly Offset	27
140 ft Main Boom Length – 15° Fly Offset	27
140 ft Main Boom Length – 30° Fly Offset	28
140 ft Main Boom Length – 45° Fly Offset	28
Main Boom Lift Capacity Charts – Optional (Metric)	29
3 856kg Counterweight – Fully Extended Outriggers – 360° Rotation	29
3 856kg Counterweight – On Tires – Stationary – Boom Centered Over Rear	30
3 856kg Counterweight – On Tires – Pick & Carry (1.6 km/h) – Boom Centered Over Rear	30
5 216kg Counterweight – Fully Extended Outriggers – 360° Rotation	31
5 216kg Counterweight – On Tires – Stationary – Boom Centered Over Rear	32
5 216kg Counterweight – On Tires – Pick & Carry (1.6 km/h) – Boom Centered Over Rear	32
14 742kg Counterweight – Fully Extended Outriggers – 360° Rotation	33
14 742kg Counterweight – On Tires – Stationary – Boom Centered Over Rear	34
14 742kg Counterweight – On Tires – Pick & Carry (1.6 km/h) – Boom Centered Over Rear	34
17 917kg Counterweight – Fully Extended Outriggers – 360° Rotation	35
Fly Attachment Lift Capacity Charts – Optional (Metric)	36
3 856kg Counterweight – Fully Extended Outriggers – 360° Rotation	36
42.67m Main Boom Length – 2° Fly Offset	36
42.67m Main Boom Length – 15° Fly Offset	36
42.67m Main Boom Length – 30° Fly Offset	36
42.67m Main Boom Length – 45° Fly Offset	36
5 216kg Counterweight – Fully Extended Outriggers – 360° Rotation	37
42.67m Main Boom Length – 2° Fly Offset	37
42.67m Main Boom Length – 15° Fly Offset	37
42.67m Main Boom Length – 30° Fly Offset	37
42.67m Main Boom Length – 45° Fly Offset	37



For Rental Inquiries Please Call (800) 335-3148 Or Visit Us On The Web At Southwaycrane.com

5460 (supersedes 5424) - 0506 - N3

14 742kg Counterweight – Fully Extended Outriggers – 360° Rotation	38
42.67m Main Boom Length – 2° Fly Offset	38
42.67m Main Boom Length – 15° Fly Offset	38
42.67m Main Boom Length – 30° Fly Offset	39
42.67m Main Boom Length – 45° Fly Offset	39
17 917kg Counterweight – Fully Extended Outriggers – 360° Rotation	40
42.67m Main Boom Length – 2° Fly Offset	40
42.67m Main Boom Length – 15° Fly Offset	40
42.67m Main Boom Length – 30° Fly Offset	41
42.67m Main Boom Length – 45° Fly Offset	41



For Rental Inquiries Please Call (800) 335-3148 Or Visit Us On The Web At Southwaycrane.com

5460 (supersedes 5424)–0506–N3

This Page Intentionally Blank

HTC-8690

Link-Belt Cranes

This material is for informational purposes only and is not intended to be a substitute for an operation manual. Only persons that are trained in the operation of heavy machinery should do so. For inquiries, call Southway Crane & Rigging, LLC at (800) 335-3148.

Boom, Attachments, and Upper Structure

■ Boom

Design – Five section, formed construction of extra high tensile steel consisting of one base section and four telescoping sections. The two plate design of each section has multiple longitudinal bends for superior strength. Each telescoping section extends independently by means of one double-acting, single stage hydraulic cylinder with integrated holding valves.

Boom

- 38–140 ft (11.6–42.7m) five section boom
- Integral boom dolly connection
- Five boom extend modes (EM1 through EM5), controlled from the operator's cab, provide superior capacities by varying the extension of the telescoping sections:
 - EM1 extends to 140.0 ft (42.7m)
 - EM2 extends to 127.3 ft (38.8m)
 - EM3 extends to 115.8 ft (35.3m)
 - EM4 extends to 102.0 ft (31.1m)
 - EM5 extends to 76.5 ft (23.3m)
- Mechanical boom angle indicator
- Maximum tip height for each extend mode is:
 - EM1 is 148 ft (45.1m)
 - EM2 is 135 ft (41.1m)
 - EM3 is 124 ft (37.8m)
 - EM4 is 110 ft (33.5m)
 - EM5 is 84 ft (25.6m)

Boom Wear Pads

- Wear pads with Teflon inserts that self-lubricate the boom sections
- Bottom wear pads are universal for all boom sections
- Top wear pads are universal for all boom sections

Boom Head

- Five 16.5 in (41.9cm) root diameter nylon sheaves to handle up to ten parts of line
- Easily removable wire rope guards
- Rope dead end lugs on each side of the boom head
- Boom head is designed for quick-reeve of the hook block

Boom Elevation

- One double acting hydraulic cylinder with integral holding valve
- Boom elevation: -3° to 80°

Auxiliary Lifting Sheave – Optional

- Single 16.5 in (41.9m) root diameter nylon sheave
- Easily removable wire rope guards
- Does not affect erection of the fly or use of the main head sheaves

Hook Blocks and Balls – Optional

- 40 ton (36.3mt) 4 sheave quick-reeve hook block with safety latch
- 60 ton (54.4mt) 4 sheave quick-reeve hook block with safety latch
- 90 ton (81.6mt) 6 sheave quick-reeve hook block with safety latch
- 8.5 ton (7.7mt) swivel and non-swivel hook balls with safety latch
- 10 ton (9.1mt) swivel and non-swivel hook balls with safety latch

Fly – Optional

- 35 ft (10.7m) one piece lattice fly, stowable, offsettable to 2° , 15° , 30° , and 45° . Maximum tip height is 182 ft (55.5m).
- 35 ft–58 ft (10.7–17.7m) two piece bi-fold lattice fly, stowable, offsettable to 2° , 15° , 30° , and 45° . Maximum tip height is 205 ft (62.5m).

Fly Extensions – Optional

- One 16 ft (4.9m) lattice extension, equipped with two 16.5 in (41.9cm) root diameter nylon sheaves, to be mounted between the boom head and fly options. Maximum tip height is 221 ft (67.4m).
- Two 16 ft (4.9m) lattice extensions, one equipped with two 16.5 in (41.9cm) root diameter nylon sheaves, to be mounted between the boom head and fly options. Maximum tip height is 237 ft (72.2m). Minimum of 14,500 lb (6 577.1kg) of counterweight required.

■ Upper Operator's Cab and Controls

Environmental Cab – Fully enclosed, one person cab of galvaneal steel structure with acoustical insulation.

Equipped with:

- Tinted and tempered glass windows
- Extra-large fixed front window with windshield wiper and washer
- Swing up roof window with windshield wiper
- Sliding left side door with large fixed window
- Sliding rear and right side windows for ventilation
- Six way adjustable, cushioned seat with seat belt and storage compartment
- Engine dependent warm-water heater with air ducts for front windshield defroster and cab floor
- Defroster fan for the front window
- Bubble level
- Circulating fan
- Adjustable sun visor
- Dome light
- Cup holder
- Fire extinguisher
- Left side viewing mirror
- Pull-out cabwalk
- Two position travel swing lock

Air Conditioning – Optional – Integral with cab heating system utilizing the same ventilation outlets

Armrest Controls – Two dual axis hydraulic joystick controllers or optional single axis hydraulic controllers for:

- Swing
- Boom hoist
- Main rear winch
- Auxiliary front winch – optional
- Drum rotation indication
- Drum rotation indicator activation switch
- Winch high/low speed and disable switch(es)
- Third wrap selector switch – optional
- Counterweight handling switch
- Telescopic override switches
- Warning horn button

Outrigger Controls – Hand held control box with umbilical cord gives the operator the freedom to view operation while setting the outriggers.

Foot Controls

- Boom telescope
- Swing brake
- Engine throttle

Right Front Console – Controls and indicators for:

- Engine ignition
- Engine throttle lock
- Pump enable
- Function disable
- Swing park brake
- Front windshield wiper and washer
- Cab floodlights
- Warning horn
- Heating controls
- Console dimmer switch
- Bubble level
- 12 volt power connection
- Air conditioning – optional
- Boom floodlight – optional
- Rotating beacon/Strobe light – optional

Cab Instrumentation – Ergonomically positioned, analog instrumentation for crane operation including:

- Check and stop engine indicators
- Engine coolant temperature with warning indicator
- Hydraulic oil temperature with warning indicator
- Low air pressure warning indicator
- Fuel level with warning indicator
- Tachometer

Rated Capacity Limiter – Microguard 540 color graphic audio-visual warning system integrated into the dash with anti-two block and function limiter. Operating data available includes:

- Crane configuration
- Boom length and angle
- Boom head height
- Allowed load and % of allowed load
- Boom angle
- Radius of load
- Actual load
- Counterweight removal
- Operator settable alarms (include):
 - Maximum and minimum boom angles
 - Maximum and minimum tip height
 - Maximum boom length
 - Left/right swing positions
 - Operator defined area (imaginary plane)

Integrated Third Wrap Indicator – Optional – Microguard color display visually and audibly warns the operator when the wire rope is on the first/bottom layer and when the wire rope is down to the last three wraps.

Internal RCL Light Bar – Optional – Visually informs the operator when crane is approaching maximum load capacity with a series of green, yellow, and red lights.

External RCL Light Bar – Optional – Visually informs the ground crew when crane is approaching maximum load capacity with a series of green, yellow, and red lights.

■ Swing

Motor/Planetary – Bi-directional hydraulic swing motor mounted to a planetary reducer for 360° continuous smooth swing at 1.7 rpm.

Swing Park Brake – 360°, electric over hydraulic, (spring applied/hydraulic released) multi-disc brake mounted on the speed reducer. Operated by a switch from the operator's cab.

Swing Brake – 360°, foot operated, hydraulic applied disc brake mounted to the speed reducer.

Swing Lock – Two-position swing lock (boom over front or rear) operated from the operator's cab.

360° Positive Swing Lock – Optional – Meets New York City requirement.

■ Electrical

Swing Alarm – Audio warning device signals when the upper is swinging.

Lights

- Two working lights on front of the cab
- One rotating amber beacon on top of the cab – optional
- One amber strobe beacon on top of the cab – optional
- Boom floodlight – optional

■ Additional Equipment

- Left side aluminum storage box

■ Load Hoist System

Load Hoist Performance

Main (Rear) and Auxiliary (Front) Winches – 3/4 in (19mm) Rope										
Layer	Maximum Line Pull		Normal Line Speed		High Line Speed		Layer		Total	
	lb	kg	ft/min	m/min	ft/min	m/min	ft	m	ft	m
1	16,880	7 656.6	179	54.6	356	108.5	114	34.7	114	34.7
2	15,519	7 039.3	195	59.4	387	118.0	124	37.8	238	72.5
3	14,362	6 514.5	211	64.3	418	127.4	134	40.8	372	113.4
4	13,365	6 062.3	226	68.9	449	136.9	144	43.9	516	157.3
5	12,497	5 668.5	242	73.8	480	146.3	154	46.9	670	204.2
6	---	---	---	---	---	---	164	50.0	834	254.2

Wire Rope Application		Diameter		Type	Maximum Permissible Load	
		in	mm		lb	kg
Main (Rear) Winch	Standard	3/4	19	18x19 rotation resistant – right regular lay (Type RB)	12,920	5 860.5
	Optional	3/4	19	36x7 rotation resistant – right regular lay (Type ZB)	15,600	7 076.2
Auxiliary (Front) Winch	Standard	3/4	19	18x19 rotation resistant – right regular lay (Type RB)	12,920	5 860.5
	Optional	3/4	19	36x7 rotation resistant – right regular lay (Type ZB)	15,600	7 076.2

2M Main and Optional Auxiliary Winches

- Axial piston, full and half displacement (2-speed) motors driven through planetary reduction unit for positive control under all load conditions.
- Grooved lagging
- Power up/down mode of operation
- Hoist drum cable follower – optional

- Drum rotation indicator
- Drum diameter: 16 in (40.6cm)
- Rope length:
 - Main: 730 ft (222.5m)
 - Auxiliary: 600 ft (182.9m) or 730 ft (222.5m)
- Maximum rope storage: 834 ft (254.2m)
- Terminator style socket and wedge

Third wrap indicator – optional – Visually and audibly warns the operator when the wire rope is on the bottom layer and when the wire rope is down to the last three wraps.

■ Hydraulic System

All circuits of the hydraulic system are pressure compensated.

Counterbalance Valves – All hoist motors, boom extend cylinders, and boom hoist cylinders are equipped with counterbalance valves to provide load lowering and to prevent accidental load drop if hydraulic power is suddenly reduced.

Hydraulic Oil Coolers – Two carrier mounted coolers remove heat from the hydraulic oil. One is integral to the engine radiator/charge air cooler and the other is mounted in left side access ladder.

Boom Hoist Float Valves (Optional) – For transporting the boom over the rear of the crane with a boom dolly. Allows hydraulic oil within the boom hoist cylinder to flow between piston side and case side, allowing the boom to float while on the boom dolly.

Swing Brake Release – For transporting the boom over the rear of the crane with a boom dolly. Holds the 360° swing park brake in the released position allowing free rotation of the upper structure.

■ Counterweight

Standard – Total of 11,500 lb (5 216kg) of total counterweight consisting of three, hydraulically removable counterweights. Assembled and disassembled by hydraulic cylinders controlled from the operator's cab with capacities for:

- 0 lb (0kg) counterweight
- 2,500 lb (1 134.0kg) counterweight
- 5,500 lb (2 494.8kg) counterweight
- 8,500 lb (3 855.5kg) counterweight
- 11,500 lb (5 216.3kg) counterweight

Optional – 15,000 lb (6 803.9kg) in addition to standard counterweight for a total of 26,500 lb (12 020.2kg) with additional capacities for:

- 14,500 lb (6 577.1kg) counterweight
- 20,500 lb (9 298.6kg) counterweight
- 23,500 lb (10 659.4kg) counterweight
- 26,500 lb (12 020.2kg) counterweight

Optional – 21,000 lb (9 525.4kg) in addition to standard counterweight for a total of 32,500 lb (14 741.8kg) with additional capacities for:

- 14,500 lb (6 577.1kg) counterweight
- 17,500 lb (7 937.9kg) counterweight
- 20,500 lb (9 298.6kg) counterweight
- 23,500 lb (10 659.4kg) counterweight
- 26,500 lb (12 020.2kg) counterweight
- 29,500 lb (13 381.0kg) counterweight
- 32,500 lb (14 741.8kg) counterweight

Optional – 28,000 lb (12 700.6kg) in addition to standard counterweight for a total of 39,500 lb (17 916.9kg) with additional capacities for:

- 14,500 lb (6 577.1kg) counterweight
- 17,500 lb (7 937.9kg) counterweight
- 20,500 lb (9 298.6kg) counterweight
- 23,500 lb (10 659.4kg) counterweight
- 26,500 lb (12 020.2kg) counterweight
- 29,500 lb (13 381.0kg) counterweight
- 32,500 lb (14 741.8kg) counterweight
- 39,500 lb (17 916.9kg) counterweight*

Low speed jobsite travel is offered for these optional counterweight configurations and a boom dolly or boom trailer may be required for on-highway travel.

* Overall width of the crane increases to 11 ft (3.4m) for this counterweight configuration

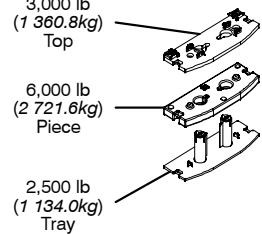
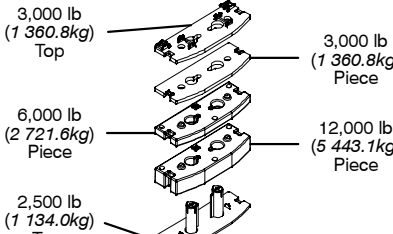
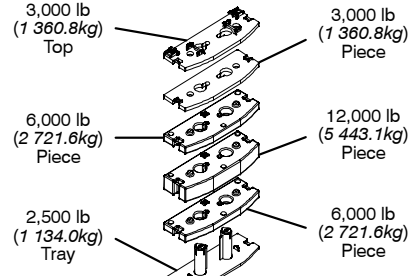
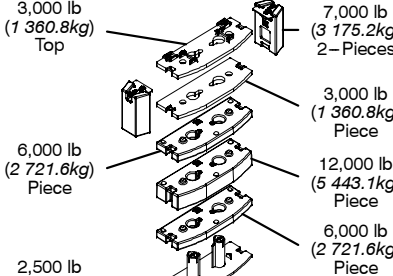
 <p style="text-align: center;">11,500 lb (5 216.3kg)</p>	 <p style="text-align: center;">26,500 lb (12 020.2kg)</p>						
 <p style="text-align: center;">32,500 lb (14 741.8kg)</p>	 <p style="text-align: center;">39,500 lb (17 916.9kg)</p>						
Counterweight Packages	11,500 lb (5 216.3kg) – Standard 26,500 (12 020.2kg) – Optional 32,500 (14 741.8kg) – Optional 39,500 (17 916.9kg) – Optional						
Counterweight Modules	2,500 lb (1 134.0kg) Tray	6,000 lb (2 721.6kg) Piece	3,000 lb (1 360.8kg) Top	3,000 lb (1 360.8kg) Piece	12,000 lb (5 443.1kg) Piece	6,000 lb (2 721.6kg) Piece	7,000 lb (3 175.2kg) 2–Pieces
Counterweight Usage Configurations	0 lb (0kg)						
	2,500 lb (1 134.0kg)	X					
	5,500 lb (2 494.8kg)	X		X			
	8,500 lb (3 855.5kg)	X	X				
	11,500 lb (5 216.3kg)	X	X	X			
	14,500 lb (6 577.1kg)	X	X	X	X		
	17,500 lb (7 937.9kg)	X	X	X		X	
	20,500 lb (9 298.6kg)	X	X	X	X	X	
	23,500 lb (10 659.4kg)	X	X	X		X	
	26,500 (12 020.2kg)	X	X	X	X	X	
	29,500 lb (13 381.0kg)	X	X	X		X	X
	32,500 (14 741.8kg)	X	X	X	X	X	
	39,500 (17 916.9kg)	X	X	X	X	X	X

Carrier

General

- 8 ft 6 in (2.6 m) wide
- 23 ft 10 in (7.26m) wheelbase (centerline of first axle to centerline of fourth axle)
- **Frame** – Box-type, torsion resistant, welded construction made of high tensile steel. Equipped with front and rear towing and tie-down lugs, tow connections, and access ladders.

Outriggers

Boxes – Two double box, front and rear welded to the carrier frame

Beams and Jacks – Four dual stage beams with Confined Area Lifting Capacities (CALC) provide selectable outrigger extensions of full, intermediate, and retracted positions. Jacks with integral check valves, hydraulically controlled from the operator's cab and on both sides of carrier. A fifth front bumper outrigger with integral check valves is hydraulically controlled from the operator's cab and at the front bumper of carrier.

Pontoons – Four lightweight, stow'n go, 23.5" x 27.25" (59.7 x 69.2cm) hexagonal steel pontoons with a contact area of 485 in² (3 129cm²) can be stored for road travel in either the storage racks on the carrier or under the outrigger boxes.

Main Jack Reaction – 106,000 lb (48 080.8kg) force and 217 psi (1 496.2kPa) ground bearing pressure

Steering and Axles

- Sheppard full integral master gear/slave gear steering system provides hydraulic assisted steering with mechanical link between steering wheel and wheels
- **Drive** – 8 x 4 for on/off-highway travel
- **Axle 1 & 2** – Tandem steered, non-driven
- **Axle 3 & 4** – Tandem non-steered, driven with reduction: 5.38 to 1
- **Inter-Axle Differential Lock** – Traction adding device that locks axle 3 with axle 4. Operated by a switch from the carrier cab.

Suspension

Front – Raydan Air Link walking beam air suspension

Rear – Raydan Air Link walking beam air suspension

- **Axle Lift System – Optional** – Improves rear tire ground clearance when the crane is up on outriggers. The rear tandem axles are raised and lowered with a switch in the carrier cab. The axle lift system can be controlled with a switch on both sides of the carrier.

Tires and Wheels

Front – Four (single) 445/65R22.5 tires on aluminum disc wheels

Rear – Eight (dual) 12R22.5 tires on aluminum disc wheels

- Spare tires and wheels – optional
- Tire inflation kit – optional

Brakes

Service – Full air anti-lock (ABS) brakes on all wheel ends. Dual circuit compressed air system with air dryer.

Parking/Emergency – Spring loaded type, acting on 3rd and 4th axles automatically apply when air pressure drops below 40 psi (275.8kPa) in both circuits.

Electrical

Battery – Three batteries provide 12 volt starting and operation

Lights

- Front lighting includes two main headlights, two high beam lights, two parking/directional indicators, and three cab marker lights.
- Side lighting includes three parking/directional indicators per side.
- Rear lighting includes two parking/directional indicators, two parking/brake lights, two reverse lights, three marker lights, and a license plate light.
- Other equipment includes hazard/warning system, cab light, instrument panel light, and signal horn.
- One amber strobe beacon on top of the cab – optional
- Daytime running lights – optional

Engine

Specification	Detroit Diesel Series 60
Numbers of cylinders	6
Cycle	4
Bore and Stroke: inch (mm)	5.12 x 6.30 (130x160)
Piston Displacement: in ³ (L)	778 (12.7)
Max. Brake Horsepower: hp (kW)	445 (331.8) @ 1,800 rpm 430 (320.7) @ 2,100 rpm
Peak Torque: ft lb (J)	1,450 (1 966.1) @ 1,200 rpm
Alternator: volts – amps	12 – 130
Crankcase Capacity: qt (L)	32 (30.3)
<ul style="list-style-type: none"> • Cruise control • Three-stage engine compression brake • Thermostatically controlled, hydraulically driven radiator fan • 120 volt engine block heater • Ether injection system – optional 	

Transmission

Automated – ZF AS-TRONIC (no clutch pedal) manual transmission with 12 forward gears and 2 reverse gears.

Carrier Speeds and Gradeability

ZF Astronic		Governed Speed		Gradeability (@ Peak Torque Except Creep @ Idle)
Gear	Ratio	mph	km/h	% Grade
12th	0.778	62.3	100.3	2.1
11th	1.000	48.5	78.1	3.1
10th	1.267	38.3	61.6	4.2
9th	1.629	29.8	48.0	5.8
8th	2.101	23.1	37.2	7.8
7th	2.700	18.0	29.0	10.2
6th	3.552	13.7	22.0	13.7
5th	4.565	10.6	17.1	17.8
4th	5.784	8.4	13.5	22.8
3rd	7.435	6.5	10.5	29.5
2nd	9.590	5.1	8.2	38.2
1st	12.326	3.9	6.3	49.3
Reverse (Low)	11.413	4.3	6.9	45.6
Reverse (High)	8.880	5.5	8.9	35.3
1st @ 700 rpm	12.326	1.3	2.1	20.9
Rev. (Low) @ 700 rpm	11.413	1.4	2.3	19.3
Rev. (High) @ 700 rpm	8.880	1.8	2.9	14.9

Based on a gross vehicle weight of 95,000 lb (43 091.3kg)

Fuel Tank

One 95 gal (359.6L) capacity tank

Hydraulic System

All functions are hydraulically powered allowing positive, precise control with independent or simultaneous operation of all functions.

Main Pumps

- Three fixed displacement gear pumps with automatic disconnect for the main and auxiliary winches, swing, boom hoist, control circuit, and telescope for use when pick & carry switch is in travel mode.
- One fixed displacement gear pump for steering and the front bumper outrigger
- Two fixed displacement gear pumps for engine cooling fan and main outriggers. These pumps also provide flow to the winches and boom hoist for “pick & carry” mode. Operated by a switch in the carrier cab.
- Combined pump capacity of 188 gpm (711.7Lpm)

Hydraulic Reservoir – 144 gal (545.1L) capacity equipped with sight level gauge. Diffusers built in for deaeration.

Filtration – One 10 micron, full flow, return line filter. All oil is filtered prior to return to reservoir. Accessible for easy filter replacement.

Pump Drive

All pumps are mechanically driven by the diesel engine. Main and auxiliary winches, swing, boom hoist, control circuit, and telescope pumps are mounted to an automatic pump disconnect on the rear of the transmission to aid in cold weather starting as well as to reduce pump wear while traveling.

■ Lower Cab and Controls

Environmental Cab – Fully enclosed, one person cab of composite structure with acoustical insulation. Equipped with:

- Tinted and tempered glass windows
- Roll down left side window for ventilation
- Sliding rear and right side windows for ventilation
- Windshield wiper and washer
- Six way adjustable and air suspended driver's seat with seat belt
- Two adjustable rear view mirrors
- Engine dependent warm–water heater with air ducts for windshield defroster and cab floor
- Adjustable sun visor
- Dome light
- 12 volt connection
- Fire extinguisher

Air Conditioning – Optional – Integral with cab heating system utilizing the same ventilation outlets

Cab Instrumentation – Ergonomically positioned analog instrumentation for driving including:

- Speedometer with odometer, hourmeter, trip odometer, and clock
- Front and rear air pressure with warning indicator
- Engine coolant temperature with warning indicator
- Engine oil pressure with warning indicator
- Voltage indicator with warning indicator
- Fuel level
- Tachometer

Right Side Console – Controls and indicators for:

- Transmission gear shifting
- Transmission digital readout
- Cruise controls
- Engine compression brake controls

Dash Mounted Controls For:

- Windshield wiper and washer
- Carrier lights
- Carrier/upper throttle control
- Engine cooling fan override
- Cab heater/air conditioning
- Console dimmer switch
- Engine diagnostic switch
- Park brake
- Engine ignition
- Pick & carry switch

Dash Mounted Indicator For:

- Check and stop engine
- Turn signal indication
- Park brake
- Cruise activation
- High beam headlights
- Check anti–lock brake system

Foot Controls For:

- Carrier service brakes
- Engine throttle

■ Additional Equipment

Standard:

- Aluminum full deck fenders with mud flaps
- Left and right bubble levels
- Air hose connection ports
- Clearance flags

Optional:

- Pneumatic and electrical quick disconnect connectors mounted on the rear for trailer or boom dolly brakes and lights
- Left side aluminum storage box
- Rear mounted pintle hook

Axle Loads

Base crane with full tank of fuel and no counterweight	Gross Vehicle Weight ⁽¹⁾		Front Axles		Rear Axles	
	lb	kg	lb	kg	lb	kg
	79,206	35,927	34,938	15,848	44,268	20,080
Driver in carrier cab	250	113	315	143	-65	-29
Rear pintle hook	13	6	-6	-3	19	8
Pneumatic and electrical connectors for trailer or boom dolly	11	5	-4	-2	15	7
Carrier aluminum storage box	59	27	28	13	31	14
Air ride lift system – rear axles	48	22	0	0	48	22
Ether injection	13	6	12	5	1	1
Air conditioning – carrier	45	20	55	25	-10	-4
Hoist drum follower – main	69	31	-35	-16	104	47
Auxiliary winch with 600 ft (182.9m) of 3/4" (19mm) type "RB" rope	731	332	-239	-108	970	440
Hoist drum follower – auxiliary	69	31	-21	-10	90	41
Substitute 600 ft (182.9m) of rope with 730 ft (222.5m) of rope – auxiliary	163	74	-54	-24	217	98
Remove 730 ft (222.5m) of rope from rear (main) winch	-931	-422	373	169	-1,304	-591
Remove 600 ft (182.9m) of rope from front (auxiliary) winch	-768	-348	252	114	-1,020	-463
Upper aluminum storage box	42	19	-4	-2	46	21
Air conditioner – operator's cab	220	100	-7	-3	227	103
360° mechanical swing lock	140	64	21	9	119	54
2,500 lb (1 134.0kg) counterweight tray on upper	2,544	1 154	-1,255	-569	3,799	1 723
3,000 lb (1 360.8kg) counterweight on upper	2,981	1 352	-1,471	-667	4,452	2 019
6,000 lb (2 721.6kg) counterweight on upper	6,000	2 722	-2,961	-1 343	8,961	4 065
6,000 lb (2 721.6kg) counterweight on upper	6,000	2 722	-2,961	-1 343	8,961	4 065
12,000 lb (5 443.1kg) counterweight on upper	12,050	5 466	-5,947	-2 697	17,997	8 163
3,000 lb (1 360.8kg) top counterweight on upper	3,009	1 365	-1,485	-674	4,494	2 038
Floodlight to the front of boom base section	7	3	6	3	1	1
Fly mounting brackets to boom base section for fly options	176	80	136	62	40	18
35 ft (10.7m) offsettable, one-piece lattice fly – stowed	1,591	722	1,539	698	52	24
35–58 ft (10.7–17.7m) offsettable, two-piece (bi-fold) lattice fly – stowed	2,263	1 026	1,886	855	377	171
Auxiliary lifting sheave	110	50	200	91	-90	-41
40 ton (36.3mt) 4-sheave hook block at front bumper	900	408	1,570	712	-670	-304
60 ton (54.4mt) 4-sheave hook block at front bumper	1,109	503	1,935	878	-826	-375
90 ton (81.6mt) 6-sheave hook block at front bumper	1,554	705	2,711	1 230	-1,157	-525
8.5 ton (7.7mt) hook ball at front bumper	360	163	628	285	-268	-122
10 ton (9.1mt) hook ball at front bumper	580	263	1,012	459	-432	-196

Counterweight Load Transfer	Front Axles		Rear Axles	
	lb	kg	lb	kg
Transfer 2,500 lb (1 134.0kg) counterweight tray to carrier deck	3,194	1 449	-3,194	-1 449
Transfer 3,000 lb (1 360.8kg) counterweight to carrier deck	3,742	1 697	-3,742	-1 697
Transfer 6,000 lb (2 721.6kg) counterweight to carrier deck	7,532	3 416	-7,532	-3 416
Transfer 6,000 lb (2 721.6kg) counterweight to carrier deck	7,532	3 416	-7,532	-3 416
Transfer 12,000 lb (5 443.1kg) counterweight to carrier deck	15,128	6 862	-15,128	-6 862
Transfer 3,000 lb (1 360.8kg) top counterweight to carrier deck	3,778	1 714	-3,778	-1 714

Axle	Maximum Load @ 65 mph (105km/h)
Front	46,400 lb (21 047kg) – aluminum disc wheels with 445/65R22.5 tires
Rear	52,000 lb (23 587kg) – aluminum disc wheels with 12R22.5 tires

(1) Adjust gross vehicle weight and axle loading according to component weight. All weights are ±3%.

Axle Loads with 2–Axle or 3–Axle Boom Dolly

Base crane with full tank of fuel and no counterweight	Gross Vehicle Weight (1)		Front Axles		Rear Axles		Dolly Axles	
	lb	kg	lb	kg	lb	kg	lb	kg
	79,206	35,927	29,457	13,367	35,680	16,184	14,069	6,382
Nelson 2–axle boom dolly	6,000	2 722	0	0	0	0	6,000	2 722
Nelson 3–axle boom dolly	9,000	4 082	0	0	0	0	9,000	4 082
Driver in carrier cab	250	113	315	143	-65	-29	0	0
Rear pintle hook	13	6	-6	-3	19	8	0	0
Pneumatic and electrical connectors for trailer or boom dolly	11	5	-4	-2	15	7	0	0
Carrier aluminum storage box	59	27	28	13	31	14	0	0
Air ride lift system – rear axles	48	22	0	0	48	22	0	0
Ether injection	13	6	12	5	1	1	0	0
Air conditioning – carrier	45	20	55	25	-10	-4	0	0
Hoist drum follower – main	69	31	53	24	16	7	0	0
Auxiliary winch with 600 ft (182.9m) of 3/4" (19mm) type "RB" rope	731	332	435	197	296	134	0	0
Hoist drum follower – auxiliary	69	31	40	18	29	13	0	0
Substitute 600 ft (182.9m) of rope with 730 ft (222.5m) of rope – auxiliary	163	74	97	44	66	30	0	0
Remove 730 ft (222.5m) of rope from rear (main) winch	-931	-422	-623	-282	-308	-140	0	0
Remove 600 ft (182.9m) of rope from front (auxiliary) winch	-768	-348	-458	-208	-310	-140	0	0
Upper aluminum storage box	42	19	15	7	27	12	0	0
Air conditioner – operator's cab	220	100	66	30	154	70	0	0
360° mechanical swing lock	140	64	17	8	123	56	0	0
2,500 lb (1 134.0kg) counterweight tray on carrier deck	2,544	1 154	1,938	879	606	275	0	0
3,000 lb (1 360.8kg) counterweight on carrier deck	2,981	1 352	2,271	1 030	710	322	0	0
6,000 lb (2 721.6kg) counterweight on carrier deck	6,000	2 722	4,571	2 074	1,429	648	0	0
6,000 lb (2 721.6kg) counterweight on carrier deck	6,000	2 722	4,571	2 074	1,429	648	0	0
12,000 lb (5 443.1kg) counterweight on carrier deck	12,050	5 466	9,181	4 164	2,869	1 301	0	0
3,000 lb (1 360.8kg) top counterweight on upper	3,009	1 365	2,293	1 040	716	325	0	0
Flood light to the front of boom base section	7	3	1	1	1	1	5	2
Fly mounting brackets to boom base section for fly options	176	80	30	14	30	14	116	53
35 ft (10.7m) offsettable, one–piece lattice fly – stowed	1,591	722	168	76	170	77	1,253	568
35–58 ft (10.7–17.7m) offsettable, two–piece (bi–fold) lattice fly – stowed	2,263	1 026	339	154	342	155	1,583	718
Two 16 ft (4.9m) lattice inserts (stowed on 3–axle boom dolly)	1,584	718	0	0	0	0	1,584	718
Auxiliary lifting sheave	110	50	-19	-9	-19	-9	149	67
40 ton (36.3mt) 4–sheave hook block at boom head	900	408	-134	-61	-135	-61	1,169	530
60 ton (54.4mt) 4–sheave hook block at boom head	1,109	503	-165	-75	-167	-76	1,441	654
90 ton (81.6mt) 6–sheave hook block at boom head	1,554	705	-231	-105	-233	-106	2,019	916
8.5 ton (7.7mt) hook ball at boom head	360	163	-54	-24	-54	-25	468	212
10 ton (9.1mt) hook ball at boom head	580	263	-87	-39	-87	-39	754	342

Counterweight Load Transfer	Front Axles		Rear Axles		Dolly Axles	
	lb	kg	lb	kg	lb	kg
Transfer 3,000 lb (1 360.8kg) counterweight to the boom dolly	-2,271	-1 030	-710	-322	2,981	1 352
Transfer 6,000 lb (2 721.6kg) counterweight to the boom dolly	-4,571	-2 074	-1,429	-648	6,000	2 722
Transfer 6,000 lb (2 721.6kg) counterweight to the boom dolly	-4,571	-2 074	-1,429	-648	6,000	2 722
Transfer 12,000 lb (5 443.1kg) counterweight to the boom dolly	-9,181	-4 164	-2,869	-1 301	12,050	5 466
Transfer 3,000 lb (1 360.8kg) top counterweight to the boom dolly	-2,293	-1 040	-716	-325	3,009	1 365

Axle	Maximum Load @ 65 mph (105km/h)
Front	46,400 lb (21 047kg) – aluminum disc wheels with 445/65R22.5 tires
Rear	52,000 lb (23 587kg) – aluminum disc wheels with 12R22.5 tires

(1) Adjust gross vehicle weight and axle loading according to component weight. All weights are ±3%.

5460 (supersedes 5424) - 0506 - N3

11

General Dimensions

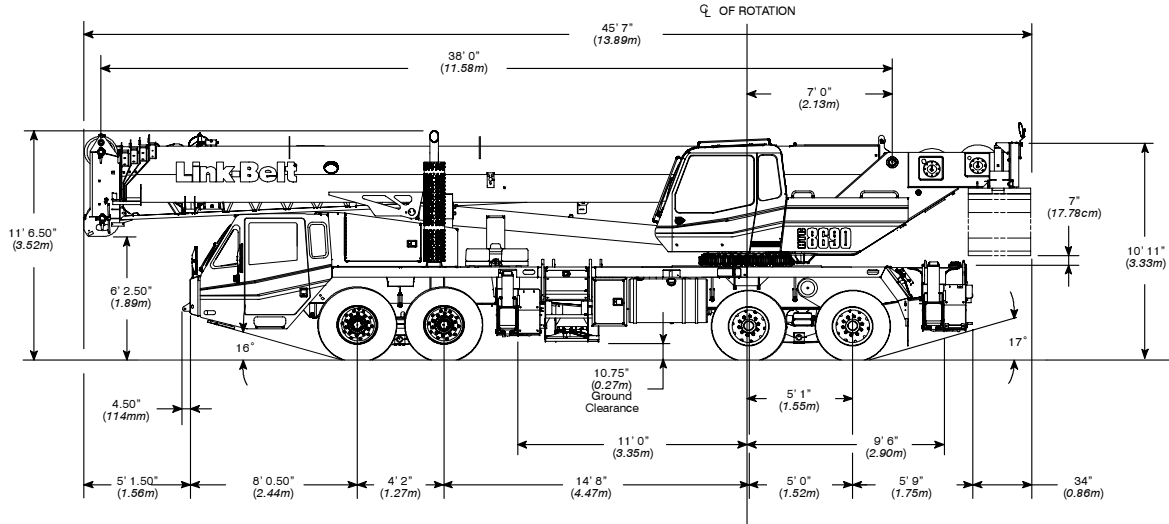

Turning Radius	English	Metric
Wall to wall over carrier	48' 4"	14.7m
Wall to wall over boom	49' 2"	15.0m
Wall to wall over boom attachment	51' 0"	15.5m
Curb to curb	44' 1"	13.4m
Centerline of tire	43' 4"	13.2m

Tail Swing	English	Metric
With counterweight	13' 8"	4.2m
Without counterweight	13' 1"	4.0m

Overall Width	English	Metric
With up to 32,500 lb (14 741.8kg) counterweight	8' 6"	2.6m
With 39,500 lb (17 916.9kg) counterweight	11' 0"	3.4m

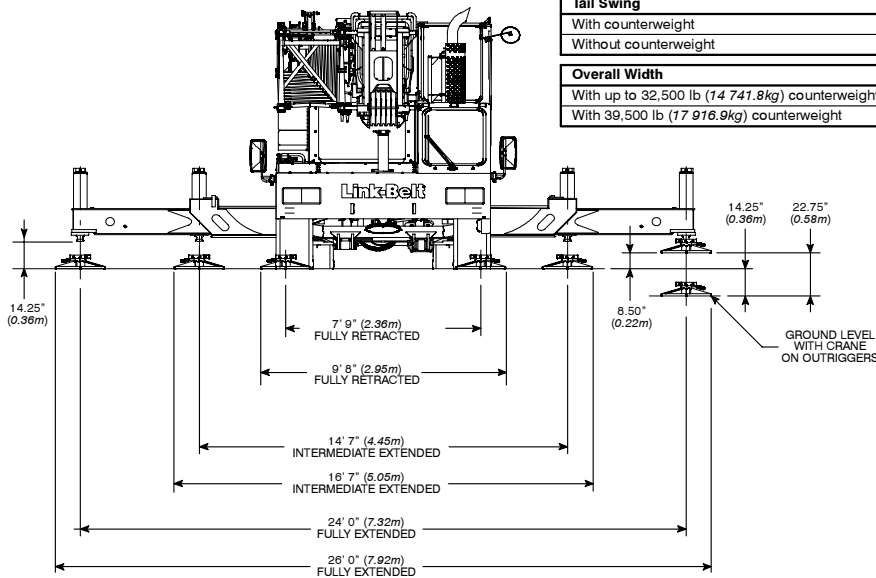

Not To Scale

Working Range Diagram

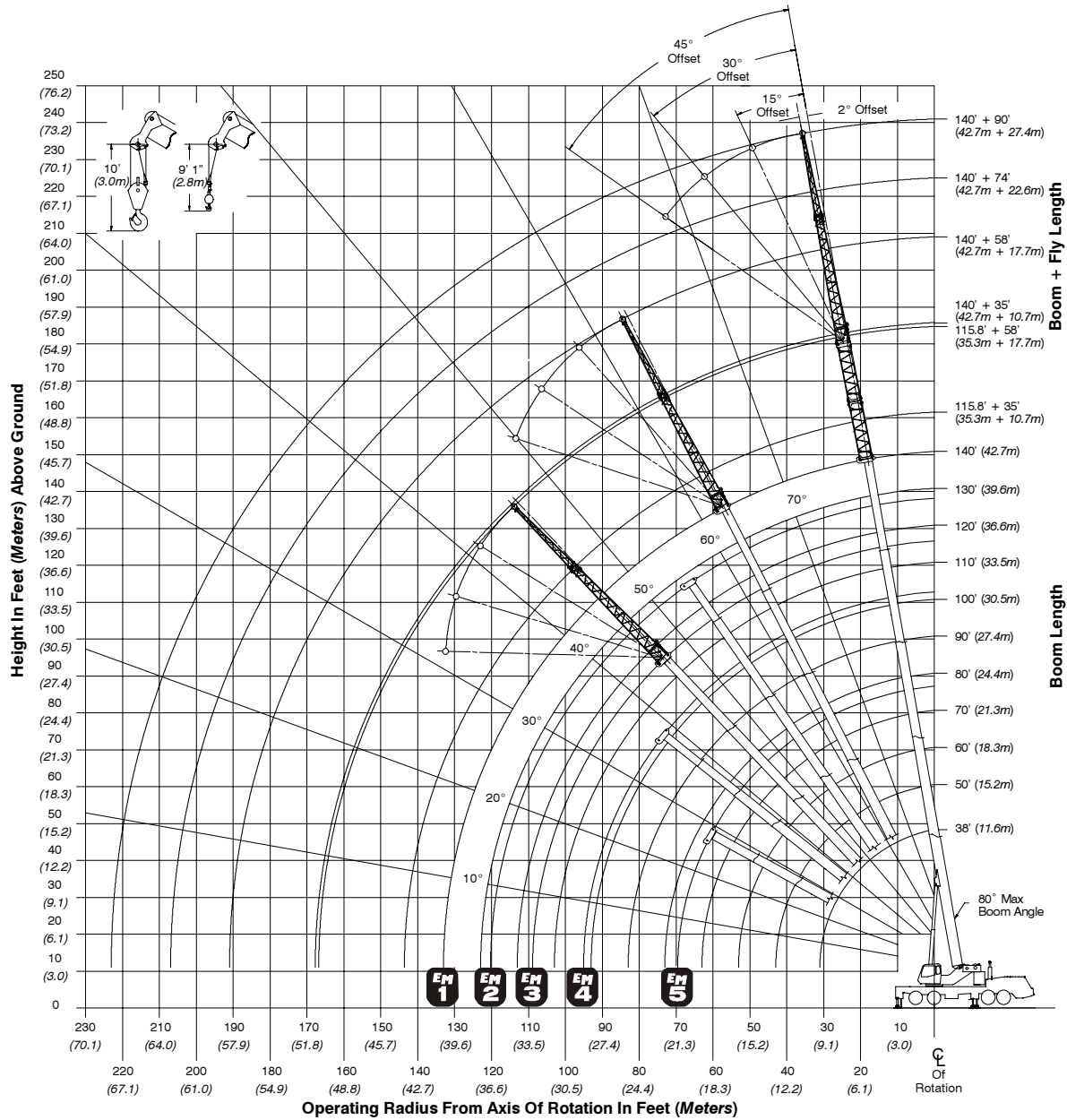

Boom Extend Modes

Boom Length		Section Length			
ft	m	T4	T3	T2	T1
50	15.2	50%			
60	18.3	91%			
70	21.3	100%	31%		
80	24.4	100%	71%		
90	27.4	100%	100%	11%	
100	30.5	100%	100%	49%	
110	33.5	100%	100%	88%	
120	36.6	100%	100%	100%	25%
130	39.6	100%	100%	100%	63%
140	42.7	100%	100%	100%	100%

Boom Length		Section Length			
ft	m	T4	T3	T2	T1
50	15.2	48%	2%		
60	18.3	48%	42%		
70	21.3	48%	82%		
80	24.4	48%	100%	21%	
90	27.4	48%	100%	60%	
100	30.5	48%	100%	98%	
110	33.5	48%	100%	100%	35%
120	36.6	48%	100%	100%	73%
127.3	38.8	48%	100%	100%	100%

Boom Length		Section Length			
ft	m	T4	T3	T2	T1
50	15.2	0%	48%		
60	18.3	0%	88%		
70	21.3	0%	100%	27%	
80	24.4	0%	100%	65%	
90	27.4	0%	100%	100%	4%
100	30.5	0%	100%	100%	41%
115.8	35.3	0%	100%	100%	100%

Boom Length		Section Length			
ft	m	T4	T3	T2	T1
50	15.2	48%	2%		
60	18.3	48%	42%		
70	21.3	48%	51%	30%	
80	24.4	48%	51%	50%	18%
90	27.4	48%	51%	50%	55%
102	31.1	48%	51%	50%	100%

Boom Length		Section Length			
ft	m	T4	T3	T2	T1
50.7	15.5	0%	51%		
63.7	19.4	0%	51%	50%	
76.5	23.3	0%	51%	50%	48%

EM
1

EM
2

EM
3

EM
4

EM
5



For Rental Inquiries Please Call (800) 335-3148 Or Visit Us On The Web At Southwaycrane.com

Main Boom Lift Capacity Charts – Standard

8,500 lb Counterweight – Fully Extended Outriggers – 360° Rotation (All Capacities Are Listed In Pounds)												
Radius (ft)	Boom Length (ft)											Radius (ft)
	38	50	60	70	76.5/80	90	100	110	120	130	140	
9	164,400*											9
10	154,600*	152,100*	117,900	89,700								10
12	129,300*	131,300*	108,800	85,000	85,100**							12
15	102,500	104,600	104,900	78,800	78,400**	57,700						15
20	74,700	77,000	77,400	70,300	76,500**	56,200	49,100	42,500				20
25	54,700	57,900	59,400	60,100	59,700	55,300	45,800	42,500	33,700	29,700		25
30	39,600	43,300	44,400	44,600	44,300	43,800	43,200	38,300	31,200	29,400	24,400	30
35		33,100	34,100	34,900	34,100	35,000	33,500	34,500	30,900	29,100	24,100	35
40		26,100	27,200	27,900	28,100	28,000	28,000	27,500	28,100	26,900	24,000	40
45			22,800	23,500	23,900	23,300	24,000	23,800	23,500	23,100	22,700	45
50			18,900	19,600	20,000	20,200	20,100	19,900	19,600	19,100	18,800	50
55				16,500	16,900	17,100	16,900	16,800	16,400	16,000	15,700	55
60				14,000	14,400	14,600	14,500	14,300	14,000	13,600	13,200	60
65					12,500	12,700	12,500	12,400	12,100	11,700	11,400	65
70					10,800	11,000	10,900	10,800	10,400	10,100	9,700	70
75						9,600	9,500	9,400	9,100	8,700	8,400	75
80						8,400	8,300	8,200	7,900	7,500	7,200	80
85							7,300	7,200	6,800	6,500	6,200	85
90							6,300	6,300	6,000	5,600	5,300	90
95								5,500	5,200	4,800	4,500	95
100								4,800	4,500	4,100	3,800	100
105									3,900	3,500	3,200	105
110									3,300	3,000	2,700	110
115										2,500	2,200	115
120										2,000	1,700	120
125											1,300	125
130											900	130

* Special Conditions Or Wire Rope Required
** 76.5 EM5 mode

This information is not for crane operation. Operator must refer to the in-cab information for crane operation. Rated lifting capacities shown on fully extended outriggers do not exceed 85% of the tipping loads and on tires do not exceed 75% of the tipping loads.



For Rental Inquiries Please Call (800) 335-3148 Or Visit Us On The Web At Southwaycrane.com

5460 (supersedes 5424)–0506–N3

15

8,500 lb Counterweight – On Tires – Stationary – Boom Centered Over Rear (All Capacities Are Listed In Pounds)								
Radius (ft)	Boom Length (ft)							Radius (ft)
	38	50	60	70	80	90	100	
10	32,200							10
12	29,000	30,400						12
15	25,000	26,500	22,300					15
20	19,700	21,400	22,300	17,700				20
25	13,100	15,700	17,100	17,700	13,600			25
30	8,800	11,400	12,700	13,300	13,600	10,800	8,900	30
35		8,400	9,600	10,200	10,600	10,800	8,900	35
40		6,100	7,400	8,000	8,400	8,600	8,500	40
45			5,600	6,200	6,600	6,800	6,800	45
50			4,300	4,900	5,200	5,400	5,400	50
55				3,800	4,100	4,300	4,300	55
60				2,900	3,200	3,400	3,400	60
65					2,400	2,600	2,600	65
70					1,800	2,000	1,900	70
75						1,400	1,400	75
80						900	900	80

8,500 lb Counterweight – On Tires – Pick & Carry (1 mph) – Boom Centered Over Rear (All Capacities Are Listed In Pounds)								
Radius (ft)	Boom Length (ft)							Radius (ft)
	38	50	60	70	80	90	100	
10	22,200							10
12	19,800	21,100						12
15	16,600	18,100	18,900					15
20	12,500	14,200	15,100	15,500				20
25	9,300	11,200	12,200	12,600	12,800			25
30	6,800	8,800	9,800	10,300	10,600	10,800	8,900	30
35		6,900	7,900	8,400	8,800	8,900	8,900	35
40		5,300	6,400	6,900	7,200	7,400	7,400	40
45			5,100	5,600	6,000	6,100	6,100	45
50			3,900	4,500	4,900	5,100	5,000	50
55				3,600	3,900	4,100	4,100	55
60				2,700	3,100	3,300	3,300	60
65					2,400	2,600	2,500	65
70					1,800	2,000	1,900	70
75						1,400	1,400	75
80						900	900	80

This information is not for crane operation. Operator must refer to the in-cab information for crane operation. Rated lifting capacities shown on fully extended outriggers do not exceed 85% of the tipping loads and on tires do not exceed 75% of the tipping loads.



For Rental Inquiries Please Call (800) 335-3148 Or Visit Us On The Web At Southwaycrane.com

11,500 lb Counterweight – Fully Extended Outriggers – 360° Rotation (All Capacities Are Listed In Pounds)													
Radius (ft)	Boom Length (ft)											Radius (ft)	
	38	50	60	70	76.5/80	90	100	110	120	130	140		
9	165,000*											9	
10	155,400*	152,100*	117,900	89,700								10	
12	131,900*	133,900*	108,800	85,000	85,100**							12	
15	104,600	106,700	106,500	78,800	78,400**	57,700						15	
20	76,400	78,600	79,000	70,300	76,500**	56,200	49,100	42,500				20	
25	57,800	61,000	61,500	63,000	62,700	55,300	45,800	42,500	33,700	29,700		25	
30	42,300	46,000	47,100	47,300	47,000	46,500	45,200	38,300	31,200	29,400	24,400	30	
35		35,300	36,300	36,500	36,300	36,200	35,700	35,100	30,900	29,100	24,100	35	
40		27,900	29,000	29,700	29,900	29,900	29,800	29,300	28,800	28,700	24,000	40	
45			23,900	24,500	25,100	24,700	24,900	25,400	25,000	24,600	23,800	45	
50			20,300	21,100	21,500	21,400	21,500	21,400	21,000	20,600	20,300	50	
55				17,900	18,300	18,500	18,400	18,200	17,900	17,500	17,100	55	
60				15,300	15,700	15,900	15,700	15,600	15,300	14,900	14,500	60	
65					13,600	13,700	13,600	13,500	13,100	12,700	12,500	65	
70					11,800	12,100	11,900	11,800	11,500	11,100	10,800	70	
75						10,600	10,500	10,400	10,000	9,700	9,300	75	
80							9,300	9,200	9,100	8,800	8,400	8,100	80
85								8,100	8,000	7,700	7,300	7,000	85
90								7,100	7,100	6,700	6,400	6,100	90
95									6,200	5,900	5,600	5,200	95
100									5,500	5,200	4,800	4,500	100
105										4,500	4,200	3,900	105
110										3,900	3,600	3,300	110
115											3,100	2,800	115
120											2,600	2,300	120
125												1,800	125
130												1,400	130

* Special Conditions Or Wire Rope Required
** 76.5 EM5 mode

This information is not for crane operation. Operator must refer to the in-cab information for crane operation. Rated lifting capacities shown on fully extended outriggers do not exceed 85% of the tipping loads and on tires do not exceed 75% of the tipping loads.



For Rental Inquiries Please Call (800) 335-3148 Or Visit Us On The Web At Southwaycrane.com

5460 (supersedes 5424)–0506–N3

17

11,500 lb Counterweight – On Tires – Stationary – Boom Centered Over Rear (All Capacities Are Listed In Pounds)								
Radius (ft)	Boom Length (ft)							Radius (ft)
	38	50	60	70	80	90	100	
10	31,600							10
12	28,500	29,900						12
15	24,600	26,100	21,900					15
20	19,400	21,100	21,900	18,600				20
25	14,600	17,200	18,100	18,600	14,800			25
30	10,000	12,600	13,800	14,400	14,800	11,800	9,400	30
35		9,400	10,600	11,200	11,600	11,800	9,400	35
40		7,000	8,200	8,800	9,200	9,400	9,400	40
45			6,400	7,000	7,400	7,600	7,500	45
50			5,000	5,600	5,900	6,100	6,100	50
55				4,400	4,800	4,900	4,900	55
60				3,400	3,800	4,000	3,900	60
65					3,000	3,200	3,100	65
70					2,300	2,500	2,400	70
75						1,900	1,800	75
80						1,400	1,300	80

11,500 lb Counterweight – On Tires – Pick & Carry (1 mph) – Boom Centered Over Rear (All Capacities Are Listed In Pounds)								
Radius (ft)	Boom Length (ft)							Radius (ft)
	38	50	60	70	80	90	100	
10	21,600							10
12	19,300	20,600						12
15	16,200	17,700	18,400					15
20	12,100	13,800	14,700	15,100				20
25	9,000	10,900	11,800	12,300	12,600			25
30	6,500	8,500	9,500	10,000	10,300	10,500	8,600	30
35		6,600	7,700	8,200	8,500	8,700	8,600	35
40		5,000	6,100	6,700	7,000	7,200	7,100	40
45			4,800	5,400	5,700	5,900	5,900	45
50			3,700	4,300	4,700	4,800	4,800	50
55				3,400	3,700	3,900	3,900	55
60				2,600	2,900	3,100	3,100	60
65					2,200	2,400	2,400	65
70					1,600	1,800	1,800	70
75						1,300	1,200	75
80						800	700	80

This information is not for crane operation. Operator must refer to the in-cab information for crane operation. Rated lifting capacities shown on fully extended outriggers do not exceed 85% of the tipping loads and on tires do not exceed 75% of the tipping loads.



For Rental Inquiries Please Call (800) 335-3148 Or Visit Us On The Web At Southwaycrane.com

Main Boom Lift Capacity Charts – Optional

32,500 lb Counterweight – Fully Extended Outriggers – 360° Rotation (All Capacities Are Listed In Pounds)												
Radius (ft)	Boom Length (ft)										Radius (ft)	
	38	50	60	70	76.5/80	90	100	110	120	130		140
8	180,000*											8
9	167,100*											9
10	158,300*	152,100*	117,900	89,700								10
12	142,700*	138,700*	108,800	85,000	85,100**							12
15	119,300	121,400	106,500	78,800	78,400**	57,700						15
20	87,600	89,800	90,200	70,300	76,500**	56,200	49,100	42,500				20
25	68,000	70,300	70,800	63,600	70,300**	55,300	45,800	42,500	33,700	29,700		25
30	54,700	57,100	57,600	58,100	58,700	54,500	45,200	38,300	31,200	29,400	24,400	30
35		47,500	49,100	49,400	49,200	48,800	42,500	35,500	30,900	29,100	24,100	35
40		40,500	41,600	41,800	41,600	41,100	38,200	33,400	30,600	28,800	24,000	40
45			34,600	34,900	34,600	34,200	33,700	30,300	29,900	28,600	23,800	45
50			29,300	29,600	29,400	28,900	28,800	27,900	27,800	26,800	23,700	50
55				25,500	25,300	26,000	24,800	24,700	25,300	24,800	23,600	55
60				22,500	22,400	22,800	21,500	22,300	22,000	21,900	22,100	60
65					20,000	20,100	20,000	19,600	19,300	20,000	19,600	65
70					17,700	17,800	17,800	17,700	18,100	17,700	17,400	70
75						15,800	16,500	16,500	16,200	15,800	15,500	75
80						14,200	14,900	14,800	14,500	14,100	13,800	80
85							13,500	13,400	13,100	12,700	12,500	85
90							12,200	12,200	11,900	11,600	11,300	90
95								11,100	10,800	10,500	10,200	95
100								10,100	9,800	9,500	9,200	100
105									8,900	8,600	8,300	105
110									8,100	7,800	7,500	110
115										7,100	6,800	115
120										6,400	6,100	120
125											5,500	125
130											5,000	130

* Special Conditions Or Wire Rope Required
** 76.5 EM5 mode

This information is not for crane operation. Operator must refer to the in-cab information for crane operation. Rated lifting capacities shown on fully extended outriggers do not exceed 85% of the tipping loads and on tires do not exceed 75% of the tipping loads.



For Rental Inquiries Please Call (800) 335-3148 Or Visit Us On The Web At Southwaycrane.com

5460 (supersedes 5424)-0506-N3

19

32,500 lb Counterweight – On Tires – Stationary – Boom Centered Over Rear (All Capacities Are Listed In Pounds)								
Radius (ft)	Boom Length (ft)							Radius (ft)
	38	50	60	70	80	90	100	
10	28,300							10
12	25,400	26,900						12
15	21,800	23,400	24,300					15
20	16,700	18,000	19,300	20,100				20
25	13,000	14,900	15,700	16,100	16,300			25
30	10,100	12,100	13,100	13,500	13,800	13,900	13,800	30
35		9,900	10,900	11,400	11,800	11,900	11,800	35
40		8,000	9,100	9,600	10,000	10,100	10,100	40
45			7,600	8,100	8,500	8,700	8,600	45
50			6,300	6,900	7,200	7,400	7,300	50
55				5,700	6,100	6,300	6,200	55
60				4,800	5,200	5,300	5,300	60
65					4,300	4,500	4,500	65
70					3,600	3,800	3,700	70
75						3,100	3,100	75
80						2,500	2,500	80
85							1,900	85
90							1,500	90

32,500 lb Counterweight – On Tires – Pick & Carry (1 mph) – Boom Centered Over Rear (All Capacities Are Listed In Pounds)								
Radius (ft)	Boom Length (ft)							Radius (ft)
	38	50	60	70	80	90	100	
10	18,200							10
12	16,000	17,500						12
15	13,200	14,800	15,600					15
20	9,500	11,300	12,200	12,700				20
25	6,700	8,600	9,600	10,000	10,400			25
30	4,400	6,500	7,500	8,000	8,300	8,500	8,500	30
35		4,700	5,800	6,300	6,700	6,900	6,800	35
40		3,300	4,400	5,000	5,300	5,500	5,500	40
45			3,300	3,900	4,200	4,400	4,400	45
50			2,300	2,800	3,200	3,400	3,300	50
55				2,000	2,400	2,600	2,500	55
60				1,300	1,700	1,900	1,800	60
65					1,100	1,200	1,200	65

This information is not for crane operation. Operator must refer to the in-cab information for crane operation. Rated lifting capacities shown on fully extended outriggers do not exceed 85% of the tipping loads and on tires do not exceed 75% of the tipping loads.



For Rental Inquiries Please Call (800) 335-3148 Or Visit Us On The Web At Southwaycrane.com

39,500 lb Counterweight – Fully Extended Outriggers – 360° Rotation (All Capacities Are Listed In Pounds)												
Radius (ft)	Boom Length (ft)										Radius (ft)	
	38	50	60	70	76.5/80	90	100	110	120	130		140
8	180,000*											8
9	167,600*											9
10	158,800*	152,100*	117,900	89,700								10
12	143,600*	138,700*	108,800	85,000	85,100**							12
15	123,700	122,600	106,500	78,800	78,400**	57,700						15
20	91,300	93,500	93,800	70,300	76,500**	56,200	49,100	42,500				20
25	71,000	73,300	73,800	63,600	73,300**	55,300	45,800	42,500	33,700	29,700		25
30	57,200	59,600	60,100	58,100	61,100	54,500	45,200	38,300	31,200	29,400	24,400	30
35		49,700	50,300	51,400	51,200	50,900	42,500	35,500	30,900	29,100	24,100	35
40		42,200	43,700	44,000	43,800	43,400	38,200	33,400	30,600	28,800	24,000	40
45			37,900	38,200	38,100	37,700	34,600	30,300	29,900	28,600	23,800	45
50			32,400	32,700	32,500	32,000	31,500	27,900	27,800	26,800	23,700	50
55				28,200	28,000	27,600	27,300	25,600	25,800	24,800	23,600	55
60				24,600	24,500	24,100	24,100	23,600	24,200	23,000	22,100	60
65					21,500	22,300	21,100	21,400	21,600	21,300	20,600	65
70					19,700	19,900	18,700	19,500	19,100	19,200	19,200	70
75						17,700	17,500	17,400	17,000	17,700	17,400	75
80						16,000	16,000	15,600	15,900	15,900	15,600	80
85							14,600	14,600	14,800	14,400	14,100	85
90							13,800	13,700	13,400	13,000	12,700	90
95								12,500	12,300	11,900	11,600	95
100								11,500	11,200	10,900	10,600	100
105									10,200	9,900	9,600	105
110									9,400	9,000	8,800	110
115										8,300	8,000	115
120										7,500	7,300	120
125											6,600	125
130											6,000	130

* Special Conditions Or Wire Rope Required
** 76.5 EM5 mode

This information is not for crane operation. Operator must refer to the in-cab information for crane operation. Rated lifting capacities shown on fully extended outriggers do not exceed 85% of the tipping loads and on tires do not exceed 75% of the tipping loads.



For Rental Inquiries Please Call (800) 335-3148 Or Visit Us On The Web At Southwaycrane.com

5460 (supersedes 5424)–0506–N3

21

Fly Attachment Lift Capacity Charts – Optional

8,500 lb Counterweight – Fully Extended Outriggers – 360° Rotation (All Capacities Are Listed In Pounds)					
140 ft Main Boom Length 2° Fly Offset			140 ft Main Boom Length 15° Fly Offset		
Radius (ft)	Fly Length (ft)		Radius (ft)	Fly Length (ft)	
	35	58		35	58
35	12,100		35		
40	12,100		40		
45	12,100	8,500	45	11,500	
50	12,100	8,400	50	11,400	
55	12,100	8,300	55	11,200	
60	12,100	8,100	60	11,000	7,200
65	11,900	8,000	65	10,800	7,000
70	10,400	7,800	70	10,600	6,800
75	9,000	7,700	75	9,700	6,700
80	7,800	7,500	80	8,500	6,500
85	6,800	7,300	85	7,400	6,300
90	5,900	6,400	90	6,400	6,200
95	5,100	5,600	95	5,600	6,000
100	4,400	4,900	100	4,800	5,600
105	3,700	4,200	105	4,200	4,900
110	3,200	3,600	110	3,600	4,300
115	2,700	3,100	115	3,000	3,700
120	2,200	2,600	120	2,500	3,200
125	1,800	2,200	125	2,100	2,700
130	1,400	1,800	130	1,700	2,300
135	1,100	1,500	135	1,300	1,900
140			140	900	1,500
145			145		1,200

This information is not for crane operation. Operator must refer to the in-cab information for crane operation. Rated lifting capacities shown on fully extended outriggers do not exceed 85% of the tipping loads and on tires do not exceed 75% of the tipping loads.



For Rental Inquiries Please Call (800) 335-3148 Or Visit Us On The Web At Southwaycrane.com

8,500 lb Counterweight – Fully Extended Outriggers – 360° Rotation (All Capacities Are Listed In Pounds)					
140 ft Main Boom Length 30° Fly Offset			140 ft Main Boom Length 45° Fly Offset		
Radius (ft)	Fly Length (ft)		Radius (ft)	Fly Length (ft)	
	35	58		35	58
35			35		
40			40		
45			45		
50			50		
55	10,000		55		
60	9,800		60		
65	9,700		65	8,800	
70	9,500		70	8,800	
75	9,400	5,700	75	8,700	
80	9,100	5,600	80	8,600	
85	8,000	5,500	85	8,400	4,900
90	7,000	5,400	90	7,400	4,900
95	6,100	5,300	95	6,400	4,800
100	5,300	5,200	100	5,600	4,800
105	4,600	5,100	105	4,800	4,700
110	3,900	4,900	110	4,200	4,700
115	3,300	4,300	115	3,500	4,700
120	2,800	3,700	120	3,000	4,100
125	2,300	3,200	125	2,500	3,600
130	1,900	2,700	130	2,000	3,100
135	1,500	2,300	135	1,500	2,600
140	1,100	1,900	140		2,100
145		1,500	145		1,700
150		1,200	150		1,300
155			155		1,000

This information is not for crane operation. Operator must refer to the in-cab information for crane operation. Rated lifting capacities shown on fully extended outriggers do not exceed 85% of the tipping loads and on tires do not exceed 75% of the tipping loads.



For Rental Inquiries Please Call (800) 335-3148 Or Visit Us On The Web At Southwaycrane.com

5460 (supersedes 5424)-0506-N3

23

11,500 lb Counterweight – Fully Extended Outriggers – 360° Rotation (All Capacities Are Listed In Pounds)							
140 ft Main Boom Length 2° Fly Offset				140 ft Main Boom Length 15° Fly Offset			
Radius (ft)	Fly Length (ft)			Radius (ft)	Fly Length (ft)		
	35	58	74		35	58	74
35	12,100			35			
40	12,100			40			
45	12,100	8,500		45	11,500		
50	12,100	8,400	6,600	50	11,400		
55	12,100	8,300	6,600	55	11,200		
60	12,100	8,100	6,600	60	11,000	7,200	
65	11,900	8,000	6,600	65	10,800	7,000	6,300
70	11,500	7,800	6,600	70	10,600	6,800	6,000
75	10,000	7,700	6,600	75	10,400	6,700	5,700
80	8,700	7,500	6,400	80	9,400	6,500	5,400
85	7,600	7,300	6,000	85	8,200	6,300	5,100
90	6,700	7,100	5,700	90	7,200	6,200	4,900
95	5,800	6,300	5,400	95	6,300	6,000	4,600
100	5,100	5,500	5,100	100	5,500	5,900	4,400
105	4,400	4,900	4,800	105	4,800	5,600	4,200
110	3,800	4,300	4,200	110	4,200	4,900	4,100
115	3,300	3,700	3,600	115	3,600	4,300	3,900
120	2,800	3,200	3,100	120	3,100	3,800	3,600
125	2,300	2,800	2,700	125	2,600	3,300	3,100
130	1,900	2,300	2,200	130	2,200	2,800	2,700
135	1,600	2,000	1,900	135	1,800	2,400	2,300
140	1,200	1,600	1,500	140	1,400	2,000	1,900
145	900	1,300	1,200	145	1,100	1,700	1,500
				150		1,300	1,200
				155		1,000	

This information is not for crane operation. Operator must refer to the in-cab information for crane operation. Rated lifting capacities shown on fully extended outriggers do not exceed 85% of the tipping loads and on tires do not exceed 75% of the tipping loads.

Link-Belt Cranes

HTC-8690

This material is for informational purposes only and is not intended to be a substitute for an operation manual. Only persons that are trained in the operation of heavy machinery should do so. For inquiries, call Southway Crane & Rigging, LLC at (800) 335-3148.



For Rental Inquiries Please Call (800) 335-3148 Or Visit Us On The Web At Southwaycrane.com

11,500 lb Counterweight – Fully Extended Outriggers – 360° Rotation (All Capacities Are Listed In Pounds)							
140 ft Main Boom Length 30° Fly Offset				140 ft Main Boom Length 45° Fly Offset			
Radius (ft)	Fly Length (ft)			Radius (ft)	Fly Length (ft)		
	35	58	74		35	58	74
35				35			
40				40			
45				45			
50				50			
55	10,000			55			
60	9,800			60			
65	9,700			65	8,800		
70	9,500			70	8,800		
75	9,400	5,700	4,600	75	8,700		
80	9,200	5,600	4,400	80	8,600		
85	8,800	5,500	4,200	85	8,600	4,900	3,700
90	7,700	5,400	4,100	90	8,100	4,900	3,500
95	6,800	5,300	3,900	95	7,200	4,800	3,400
100	6,000	5,200	3,700	100	6,300	4,800	3,300
105	5,200	5,100	3,600	105	5,500	4,700	3,200
110	4,500	5,000	3,500	110	4,800	4,700	3,100
115	3,900	4,900	3,300	115	4,100	4,700	3,000
120	3,400	4,300	3,200	120	3,500	4,600	2,900
125	2,900	3,800	3,100	125	3,000	4,100	2,800
130	2,400	3,300	3,000	130	2,500	3,600	2,700
135	2,000	2,800	2,700	135	2,000	3,100	2,700
140	1,600	2,400	2,300	140		2,600	2,600
145	1,200	2,000	1,900	145		2,200	2,200
150	900	1,600	1,600	150		1,800	1,800
155		1,300	1,200	155		1,400	1,400
160		1,000	900	160		1,000	1,100
				165			800

This information is not for crane operation. Operator must refer to the in-cab information for crane operation. Rated lifting capacities shown on fully extended outriggers do not exceed 85% of the tipping loads and on tires do not exceed 75% of the tipping loads.



For Rental Inquiries Please Call (800) 335-3148 Or Visit Us On The Web At Southwaycrane.com

5460 (supersedes 5424)–0506–N3

25

32,500 lb Counterweight – Fully Extended Outriggers – 360° Rotation (All Capacities Are Listed In Pounds)									
140 ft Main Boom Length 2° Fly Offset					140 ft Main Boom Length 15° Fly Offset				
Radius (ft)	Fly Length (ft)				Radius (ft)	Fly Length (ft)			
	35	58	74	90		35	58	74	90
35	12,100				35				
40	12,100				40				
45	12,100	8,500			45	11,500			
50	12,100	8,400	6,600		50	11,400			
55	12,100	8,300	6,600	5,200	55	11,200			
60	12,100	8,100	6,600	5,200	60	11,000	7,200		
65	11,900	8,000	6,600	5,200	65	10,800	7,000	6,300	
70	11,700	7,800	6,600	5,200	70	10,600	6,800	6,000	4,800
75	11,500	7,700	6,600	5,100	75	10,400	6,700	5,700	4,500
80	11,300	7,500	6,400	4,800	80	10,200	6,500	5,400	4,200
85	11,000	7,300	6,000	4,500	85	10,000	6,300	5,100	4,000
90	10,500	7,100	5,700	4,200	90	9,700	6,200	4,900	3,700
95	10,100	6,900	5,400	4,000	95	9,400	6,000	4,600	3,500
100	9,700	6,700	5,100	3,700	100	9,000	5,900	4,400	3,300
105	8,800	6,500	4,900	3,500	105	8,700	5,700	4,200	3,100
110	8,000	6,300	4,700	3,300	110	8,400	5,600	4,100	3,000
115	7,300	6,000	4,500	3,200	115	7,600	5,500	3,900	2,800
120	6,600	5,800	4,300	3,000	120	6,900	5,300	3,700	2,700
125	6,000	5,600	4,100	2,800	125	6,300	5,100	3,600	2,500
130	5,500	5,300	3,900	2,700	130	5,700	4,900	3,500	2,400
135	5,000	5,200	3,800	2,500	135	5,200	4,700	3,300	2,300
140	4,500	4,900	3,600	2,400	140	4,700	4,600	3,200	2,200
145	4,100	4,400	3,500	2,300	145	4,200	4,400	3,100	2,100
150	3,700	4,000	3,400	2,200	150	3,800	4,300	3,000	2,000
155	3,300	3,700	3,200	2,100	155	3,400	4,000	2,900	1,900
160	2,900	3,300	3,100	2,000	160	3,000	3,600	2,900	1,800
165	2,500	2,900	2,700	1,900	165	2,600	3,200	2,800	1,700
170		2,600	2,400	1,800	170		2,800	2,700	1,600
175		2,300	2,100	1,800	175		2,500	2,300	1,600
180		2,000	1,800	1,700	180		2,100	2,000	1,500
185		1,700	1,500	1,400	185		1,800	1,700	1,500
190			1,200	1,200	190			1,400	1,400
195			1,000	900	195			1,100	1,100
200			800		200			800	900

This information is not for crane operation. Operator must refer to the in-cab information for crane operation. Rated lifting capacities shown on fully extended outriggers do not exceed 85% of the tipping loads and on tires do not exceed 75% of the tipping loads.

32,500 lb Counterweight – Fully Extended Outriggers – 360° Rotation (All Capacities Are Listed In Pounds)									
140 ft Main Boom Length 30° Fly Offset					140 ft Main Boom Length 45° Fly Offset				
Radius (ft)	Fly Length (ft)				Radius (ft)	Fly Length (ft)			
	35	58	74	90		35	58	74	90
35					35				
40					40				
45					45				
50					50				
55	10,000				55				
60	9,800				60				
65	9,700				65	8,800			
70	9,500				70	8,800			
75	9,400	5,700	4,600		75	8,700			
80	9,200	5,600	4,400	3,600	80	8,600			
85	9,100	5,500	4,200	3,400	85	8,600	4,900	3,700	
90	9,000	5,400	4,100	3,200	90	8,500	4,900	3,500	2,900
95	8,800	5,300	3,900	3,000	95	8,400	4,800	3,400	2,700
100	8,500	5,200	3,700	2,900	100	8,200	4,800	3,300	2,600
105	8,200	5,100	3,600	2,700	105	8,000	4,700	3,200	2,400
110	8,000	5,000	3,500	2,600	110	7,800	4,700	3,100	2,300
115	7,700	4,900	3,300	2,400	115	7,600	4,700	3,000	2,200
120	7,200	4,800	3,200	2,300	120	7,400	4,600	2,900	2,100
125	6,500	4,700	3,100	2,200	125	6,700	4,500	2,800	2,000
130	5,900	4,500	3,000	2,100	130	6,000	4,400	2,700	1,900
135	5,400	4,400	2,900	2,000	135	5,400	4,300	2,700	1,800
140	4,800	4,300	2,800	1,900	140		4,200	2,600	1,800
145	4,400	4,200	2,800	1,800	145		4,100	2,600	1,700
150	3,900	4,100	2,700	1,700	150		4,000	2,500	1,600
155	3,500	4,000	2,600	1,700	155		4,000	2,500	1,600
160		3,800	2,600	1,600	160		3,900	2,500	1,500
165		3,400	2,500	1,500	165			2,500	1,500
170		3,000	2,500	1,500	170			2,500	1,400
175		2,600	2,500	1,400	175			2,500	1,400
180		2,200	2,200	1,400	180				1,400
185			1,800	1,400	185				1,400
190			1,500	1,300	190				1,400
195			1,200	1,300					
200				1,000					

This information is not for crane operation. Operator must refer to the in-cab information for crane operation. Rated lifting capacities shown on fully extended outriggers do not exceed 85% of the tipping loads and on tires do not exceed 75% of the tipping loads.



For Rental Inquiries Please Call (800) 335-3148 Or Visit Us On The Web At Southwaycrane.com

5460 (supersedes 5424)–0506–N3

27

39,500 lb Counterweight – Fully Extended Outriggers – 360° Rotation (All Capacities Are Listed In Pounds)									
140 ft Main Boom Length 2° Fly Offset					140 ft Main Boom Length 15° Fly Offset				
Radius (ft)	Fly Length (ft)				Radius (ft)	Fly Length (ft)			
	35	58	74	90		35	58	74	90
35	12,100				35				
40	12,100				40				
45	12,100	8,500			45	11,500			
50	12,100	8,400	6,600		50	11,400			
55	12,100	8,300	6,600	5,200	55	11,200			
60	12,100	8,100	6,600	5,200	60	11,000	7,200		
65	11,900	8,000	6,600	5,200	65	10,800	7,000	6,300	
70	11,700	7,800	6,600	5,200	70	10,600	6,800	6,000	4,800
75	11,500	7,700	6,600	5,100	75	10,400	6,700	5,700	4,500
80	11,300	7,500	6,400	4,800	80	10,200	6,500	5,400	4,200
85	11,000	7,300	6,000	4,500	85	10,000	6,300	5,100	4,000
90	10,500	7,100	5,700	4,200	90	9,700	6,200	4,900	3,700
95	10,100	6,900	5,400	4,000	95	9,400	6,000	4,600	3,500
100	9,700	6,700	5,100	3,700	100	9,000	5,900	4,400	3,300
105	9,300	6,500	4,900	3,500	105	8,700	5,700	4,200	3,100
110	8,900	6,300	4,700	3,300	110	8,400	5,600	4,100	3,000
115	8,500	6,000	4,500	3,200	115	8,100	5,500	3,900	2,800
120	7,800	5,800	4,300	3,000	120	7,900	5,300	3,700	2,700
125	7,100	5,600	4,100	2,800	125	7,400	5,100	3,600	2,500
130	6,500	5,300	3,900	2,700	130	6,800	4,900	3,500	2,400
135	6,000	5,200	3,800	2,500	135	6,200	4,700	3,300	2,300
140	5,500	5,000	3,600	2,400	140	5,700	4,600	3,200	2,200
145	5,000	4,800	3,500	2,300	145	5,200	4,400	3,100	2,100
150	4,500	4,700	3,400	2,200	150	4,700	4,300	3,000	2,000
155	4,100	4,500	3,200	2,100	155	4,300	4,200	2,900	1,900
160	3,700	4,100	3,100	2,000	160	3,800	4,100	2,900	1,800
165	3,400	3,700	3,100	1,900	165	3,400	4,000	2,800	1,700
170		3,400	3,000	1,800	170		3,600	2,700	1,600
175		3,000	2,800	1,800	175		3,200	2,700	1,600
180		2,700	2,500	1,700	180		2,900	2,600	1,500
185		2,400	2,200	1,600	185		2,500	2,400	1,500
190			1,900	1,600	190			2,100	1,400
195			1,700	1,500	195			1,800	1,400
200			1,400	1,300	200			1,500	1,400
205				1,100	205				1,300
210				900	210				1,000
					215				800

This information is not for crane operation. Operator must refer to the in-cab information for crane operation. Rated lifting capacities shown on fully extended outriggers do not exceed 85% of the tipping loads and on tires do not exceed 75% of the tipping loads.

39,500 lb Counterweight – Fully Extended Outriggers – 360° Rotation (All Capacities Are Listed In Pounds)									
140 ft Main Boom Length 30° Fly Offset					140 ft Main Boom Length 45° Fly Offset				
Radius (ft)	Fly Length (ft)				Radius (ft)	Fly Length (ft)			
	35	58	74	90		35	58	74	90
35					35				
40					40				
45					45				
50					50				
55	10,000				55				
60	9,800				60				
65	9,700				65	8,800			
70	9,500				70	8,800			
75	9,400	5,700	4,600		75	8,700			
80	9,200	5,600	4,400	3,600	80	8,600			
85	9,100	5,500	4,200	3,400	85	8,600	4,900	3,700	
90	9,000	5,400	4,100	3,200	90	8,500	4,900	3,500	2,900
95	8,800	5,300	3,900	3,000	95	8,400	4,800	3,400	2,700
100	8,500	5,200	3,700	2,900	100	8,200	4,800	3,300	2,600
105	8,200	5,100	3,600	2,700	105	8,000	4,700	3,200	2,400
110	8,000	5,000	3,500	2,600	110	7,800	4,700	3,100	2,300
115	7,700	4,900	3,300	2,400	115	7,600	4,700	3,000	2,200
120	7,500	4,800	3,200	2,300	120	7,400	4,600	2,900	2,100
125	7,300	4,700	3,100	2,200	125	7,200	4,500	2,800	2,000
130	7,000	4,500	3,000	2,100	130	7,100	4,400	2,700	1,900
135	6,400	4,400	2,900	2,000	135	6,400	4,300	2,700	1,800
140	5,800	4,300	2,800	1,900	140		4,200	2,600	1,800
145	5,300	4,200	2,800	1,800	145		4,100	2,600	1,700
150	4,800	4,100	2,700	1,700	150		4,000	2,500	1,600
155	4,300	4,000	2,600	1,700	155		4,000	2,500	1,600
160		3,900	2,600	1,600	160		4,000	2,500	1,500
165		3,900	2,500	1,500	165		4,000	2,500	1,500
170		3,700	2,500	1,500	170			2,500	1,400
175		3,300	2,500	1,400	175			2,500	1,400
180		2,900	2,500	1,400	180				1,400
185			2,500	1,400	185				1,400
190			2,200	1,300	190				1,400
195			1,900	1,300					
200				1,300					
205				1,300					
210				1,100					

This information is not for crane operation. Operator must refer to the in-cab information for crane operation. Rated lifting capacities shown on fully extended outriggers do not exceed 85% of the tipping loads and on tires do not exceed 75% of the tipping loads.



For Rental Inquiries Please Call (800) 335-3148 Or Visit Us On The Web At Southwaycrane.com

5460 (supersedes 5424)-0506-N3

29

Main Boom Lift Capacity Charts – Optional (Metric)

3 856kg Counterweight – Fully Extended Outriggers – 360° Rotation (All Capacities Are Listed In Kilograms)												
Radius (m)	Boom Length (m)											Radius (m)
	11.58	15.2	18.3	21.3	24.4	27.4	30.5	33.5	36.6	39.6	42.67	
3	70 800*	69 550*	53 450	40 850								3
3.5	61 350*	62 250*	50 350	39 100								3.5
4	53 500	54 450	48 900	37 450	37 400							4
4.5	47 250	48 250	48 350	35 950	35 750	26 150						4.5
5	42 200	43 200	43 400	34 600	35 250	26 150						5
6	34 500	35 550	35 750	32 150	34 700	25 450	22 250	19 250				6
7	26 600	27 850	28 200	28 850	28 700	25 200	21 150	19 250				7
8	20 500	22 000	22 450	22 550	22 450	22 200	20 650	18 800	14 950	13 400		8
9	16 350	17 800	18 250	18 500	18 200	18 150	17 950	17 550	14 200	13 300	11 050	9
10		14 850	15 250	15 550	15 600	15 600	15 600	15 400	14 050	13 200	10 950	10
12		10 750	11 450	11 700	11 850	11 700	11 850	11 800	11 650	11 500	10 850	12
14			8 800	9 100	9 250	9 300	9 250	9 200	9 050	8 900	8 750	14
16			6 850	7 150	7 350	7 400	7 350	7 300	7 150	6 950	6 850	16
18				5 800	5 950	6 000	5 950	5 900	5 750	5 650	5 500	18
20					4 900	4 950	4 900	4 850	4 750	4 600	4 450	20
22					4 050	4 150	4 100	4 050	3 900	3 750	3 650	22
24						3 450	3 400	3 400	3 250	3 100	2 950	24
26							2 850	2 850	2 700	2 550	2 450	26
28							2 400	2 400	2 250	2 100	2 000	28
30								2 000	1 850	1 700	1 600	30
32								800	1 550	1 400	1 250	32
34									1 250	1 100	1 000	34
36										850	750	36
38											500	38
40											350	40

* Special Conditions Or Wire Rope Required

This information is not for crane operation. Operator must refer to the in-cab information for crane operation. Rated lifting capacities shown on fully extended outriggers do not exceed 75% of the tipping loads and on tires do not exceed 65% of the tipping loads.

3 856kg Counterweight – On Tires – Stationary – Boom Centered Over Rear (All Capacities Are Listed In Kilograms)								
Radius (m)	Boom Length (m)							Radius (m)
	11.58	15.2	18.3	21.3	24.4	27.4	30.5	
3	14 600							3
3.5	13 500							3.5
4	12 450	13 100						4
4.5	11 500	12 150	10 100					4.5
5	10 600	11 300	10 100					5
6	8 000	9 100	9 650	8 000				6
7	6 100	7 100	7 650	7 900				7
8	4 700	5 700	6 200	6 450	6 150			8
9	3 600	4 600	5 100	5 350	5 550	4 850	4 000	9
10		3 750	4 250	4 500	4 650	4 750	4 000	10
12		2 500	3 000	3 200	3 350	3 450	3 450	12
14			2 100	2 350	2 500	2 550	2 550	14
16			1 450	1 700	1 800	1 900	1 900	16
18				1 150	1 300	1 400	1 350	18
20					900	1 000	950	20
22					600	650	650	22
24						400	400	24

3 856kg Counterweight – On Tires – Pick & Carry (1.6 km/h) – Boom Centered Over Rear (All Capacities Are Listed In Kilograms)								
Radius (m)	Boom Length (m)							Radius (m)
	11.58	15.2	18.3	21.3	24.4	27.4	30.5	
3	10 050							3
3.5	9 250							3.5
4	8 400	9 050						4
4.5	7 650	8 350	8 550					4.5
5	6 950	7 650	8 050					5
6	5 750	6 550	6 900	7 000				6
7	4 750	5 600	6 000	6 200				7
8	3 900	4 800	5 200	5 450	5 550			8
9	3 150	4 100	4 550	4 750	4 900	4 850	4 000	9
10		3 450	3 950	4 200	4 300	4 400	4 000	10
12		2 450	2 950	3 200	3 350	3 450	3 400	12
14			2 100	2 350	2 500	2 550	2 550	14
16			1 450	1 700	1 800	1 900	1 900	16
18				1 150	1 300	1 400	1 350	18
20					900	1 000	950	20
22					600	650	650	22
24						400	400	24

This information is not for crane operation. Operator must refer to the in-cab information for crane operation. Rated lifting capacities shown on fully extended outriggers do not exceed 75% of the tipping loads and on tires do not exceed 65% of the tipping loads.



For Rental Inquiries Please Call (800) 335-3148 Or Visit Us On The Web At Southwaycrane.com

5460 (supersedes 5424)-0506-N3

31

5 216kg Counterweight – Fully Extended Outriggers – 360° Rotation (All Capacities Are Listed In Kilograms)												
Radius (m)	Boom Length (m)											Radius (m)
	11.58	15.2	18.3	21.3	24.4	27.4	30.5	33.5	36.6	39.6	42.67	
3	71 100*	69 550*	53 450	40 850								3
3.5	62 600*	63 450*	50 350	39 100								3.5
4	54 600	55 550	48 900	37 450	37 400							4
4.5	48 250	49 200	48 350	35 950	35 750	26 150						4.5
5	43 100	44 100	44 250	34 600	35 250	26 150						5
6	35 250	36 250	36 450	32 150	34 700	25 450	22 250	19 250				6
7	28 250	29 450	29 700	30 000	29 400	25 200	21 150	19 250				7
8	21 800	23 300	23 750	23 850	23 700	23 450	20 650	18 800	14 950	13 400		8
9	17 450	18 900	19 350	19 450	19 300	19 100	19 050	17 550	14 200	13 300	11 050	9
10		15 800	16 200	16 500	16 150	16 550	15 950	16 300	14 050	13 200	10 950	10
12		11 500	12 000	12 200	12 600	12 250	12 450	12 350	12 350	11 800	10 850	12
14			9 400	9 700	9 850	9 900	9 850	9 800	9 650	9 500	9 350	14
16			7 450	7 750	7 900	8 000	7 950	7 900	7 750	7 600	7 450	16
18				6 300	6 450	6 500	6 450	6 400	6 250	6 100	5 950	18
20					5 350	5 400	5 400	5 350	5 200	5 050	4 900	20
22					4 450	4 550	4 500	4 450	4 350	4 150	4 050	22
24						3 850	3 800	3 750	3 600	3 450	3 350	24
26							3 200	3 150	3 050	2 900	2 750	26
28							2 700	2 700	2 550	2 400	2 300	28
30								2 250	2 150	2 000	1 900	30
32								1 050	1 800	1 650	1 550	32
34									1 500	1 350	1 250	34
36										1 100	950	36
38											750	38
40											550	40

* Special Conditions Or Wire Rope Required

This information is not for crane operation. Operator must refer to the in-cab information for crane operation. Rated lifting capacities shown on fully extended outriggers do not exceed 75% of the tipping loads and on tires do not exceed 65% of the tipping loads.

5 216kg Counterweight – On Tires – Stationary – Boom Centered Over Rear (All Capacities Are Listed In Kilograms)								
Radius (m)	Boom Length (m)							Radius (m)
	11.58	15.2	18.3	21.3	24.4	27.4	30.5	
3	14 300							3
3.5	13 300							3.5
4	12 200	12 850						4
4.5	11 300	11 950	9 900					4.5
5	10 400	11 150	9 900					5
6	8 750	9 700	9 900	8 400				6
7	6 700	7 750	8 250	8 400				7
8	5 200	6 200	6 750	7 000	6 700			8
9	4 050	5 100	5 600	5 800	5 950	5 350	4 250	9
10		4 200	4 650	4 900	5 050	5 150	4 250	10
12		2 850	3 350	3 550	3 700	3 800	3 800	12
14			2 400	2 650	2 750	2 850	2 850	14
16			1 700	1 950	2 100	2 150	2 150	16
18				1 400	1 550	1 600	1 600	18
20					1 100	1 200	1 150	20
22					800	850	850	22
24						550	550	24

5 216kg Counterweight – On Tires – Pick & Carry (1.6 km/h) – Boom Centered Over Rear (All Capacities Are Listed In Kilograms)								
Radius (m)	Boom Length (m)							Radius (m)
	11.58	15.2	18.3	21.3	24.4	27.4	30.5	
3	9 750							3
3.5	9 000							3.5
4	8 200	8 800						4
4.5	7 450	8 100	9 300					4.5
5	6 750	7 500	7 850					5
6	5 600	6 350	6 750	6 800				6
7	4 600	5 450	5 850	6 000				7
8	3 750	4 650	5 050	5 300	5 400			8
9	3 000	3 950	4 400	4 600	4 750	4 750	3 900	9
10		3 350	3 800	4 050	4 200	4 250	3 900	10
12		2 350	2 850	3 100	3 250	3 350	3 300	12
14			2 100	2 350	2 500	2 600	2 550	14
16			1 450	1 750	1 900	2 000	1 950	16
18				1 250	1 400	1 500	1 450	18
20					950	1 050	1 050	20
22					600	700	700	22
24						400	350	24

This information is not for crane operation. Operator must refer to the in-cab information for crane operation. Rated lifting capacities shown on fully extended outriggers do not exceed 75% of the tipping loads and on tires do not exceed 65% of the tipping loads.

14 742kg Counterweight – Fully Extended Outriggers – 360° Rotation (All Capacities Are Listed In Kilograms)												
Radius (m)	Boom Length (m)											Radius (m)
	11.58	15.2	18.3	21.3	24.4	27.4	30.5	33.5	36.6	39.6	42.67	
2.4	81 600*											2.4
3	72 400*	69 550*	53 450	40 850								3
3.5	66 550*	64 300*	50 350	39 100								3.5
4	61 000*	59 950*	48 900	37 450	37 400							4
4.5	55 050	55 950	48 350	35 950	35 750	26 150						4.5
5	49 250	50 200	47 000	34 600	35 250	26 150						5
6	40 450	41 400	41 600	32 150	34 700	25 450	22 250	19 250				6
7	34 000	35 050	35 250	30 000	34 700	25 200	21 150	19 250				7
8	29 150	30 200	30 400	28 150	30 200	24 950	20 650	18 800	14 950	13 400		8
9	25 150	26 300	26 500	26 550	27 000	24 700	20 500	17 550	14 200	13 300	11 050	9
10		22 100	22 800	22 900	22 750	22 550	19 750	16 450	14 050	13 200	10 950	10
12		16 650	17 100	17 200	17 050	16 900	16 700	15 200	13 850	13 050	10 850	12
14			13 400	13 500	13 400	13 450	13 200	13 000	13 350	12 750	10 750	14
16			10 850	11 150	11 250	11 200	11 000	11 050	10 900	11 050	10 700	16
18				9 250	9 350	9 350	9 300	9 350	9 450	9 300	9 150	18
20					8 150	7 900	8 200	8 150	8 000	7 850	7 700	20
22					7 000	7 000	7 050	7 000	6 850	6 700	6 600	22
24						6 150	6 100	6 100	5 950	5 800	5 750	24
26							5 350	5 350	5 250	5 100	4 950	26
28							4 700	4 700	4 600	4 450	4 350	28
30								4 150	4 050	3 900	3 800	30
32								2 800	3 550	3 400	3 300	32
34									3 150	3 000	2 900	34
36										2 650	2 550	36
38											2 200	38
40											1 950	40

* Special Conditions Or Wire Rope Required

This information is not for crane operation. Operator must refer to the in-cab information for crane operation. Rated lifting capacities shown on fully extended outriggers do not exceed 75% of the tipping loads and on tires do not exceed 65% of the tipping loads.

14 742kg Counterweight – On Tires – Stationary – Boom Centered Over Rear (All Capacities Are Listed In Kilograms)								
Radius (m)	Boom Length (m)							Radius (m)
	11.58	15.2	18.3	21.3	24.4	27.4	30.5	
3	12 800							3
3.5	11 800							3.5
4	10 850	11 550						4
4.5	10 000	10 750	11 000					4.5
5	9 350	10 000	10 400					5
6	7 700	8 200	8 950	9 200				6
7	6 550	7 300	7 700	7 750				7
8	5 550	6 400	6 800	7 000	7 100			8
9	4 700	5 600	6 050	6 250	6 350	6 300	6 250	9
10		4 900	5 350	5 600	5 750	5 750	5 750	10
12		3 750	4 250	4 450	4 600	4 700	4 650	12
14			3 300	3 550	3 750	3 800	3 800	14
16			2 600	2 850	3 000	3 100	3 050	16
18				2 250	2 400	2 500	2 450	18
20					1 900	2 000	2 000	20
22					1 500	1 550	1 550	22
24						1 200	1 200	24
26							850	26
28							600	28

14 742kg Counterweight – On Tires – Pick & Carry (1.6 km/h) – Boom Centered Over Rear (All Capacities Are Listed In Kilograms)								
Radius (m)	Boom Length (m)							Radius (m)
	11.58	15.2	18.3	21.3	24.4	27.4	30.5	
3	8 250							3
3.5	7 500							3.5
4	6 750	7 450						4
4.5	6 050	6 800	7 050					4.5
5	5 450	6 200	6 600					5
6	4 400	5 200	5 600	5 750				6
7	3 500	4 350	4 800	5 000				7
8	2 750	3 650	4 100	4 300	4 450			8
9	2 100	3 000	3 450	3 700	3 850	3 850	3 850	9
10		2 450	2 950	3 200	3 350	3 400	3 400	10
12		1 550	2 100	2 350	2 500	2 550	2 550	12
14			1 400	1 650	1 850	1 900	1 900	14
16			850	1 100	1 250	1 350	1 300	16
18				650	800	900	900	18
20					450	550	500	20

This information is not for crane operation. Operator must refer to the in-cab information for crane operation. Rated lifting capacities shown on fully extended outriggers do not exceed 75% of the tipping loads and on tires do not exceed 65% of the tipping loads.

17 917kg Counterweight – Fully Extended Outriggers – 360° Rotation (All Capacities Are Listed In Kilograms)												
Radius (m)	Boom Length (m)											Radius (m)
	11.58	15.2	18.3	21.3	24.4	27.4	30.5	33.5	36.6	39.6	42.67	
2.4	81 600*											2.4
3	72 650*	69 550*	53 450	40 850								3
3.5	66 800*	64 300*	50 350	39 100								3.5
4	61 600*	59 950*	48 900	37 450	37 400							4
4.5	56 750	56 100	48 350	35 950	35 750	26 150						4.5
5	51 250	52 250	47 000	34 600	35 250	26 150						5
6	42 100	43 100	43 300	32 150	34 700	25 450	22 250	19 250				6
7	35 450	36 500	36 700	30 000	34 700	25 200	21 150	19 250				7
8	30 450	31 450	31 700	28 150	31 500	24 950	20 650	18 800	14 950	13 400		8
9	26 450	27 550	27 750	26 550	28 000	24 700	20 500	17 550	14 200	13 300	11 050	9
10		24 250	24 450	25 000	24 900	24 650	19 750	16 450	14 050	13 200	10 950	10
12		18 300	18 750	18 850	18 750	18 550	17 550	15 200	13 850	13 050	10 850	12
14			14 800	14 900	14 800	14 600	14 450	13 550	13 400	12 750	10 750	14
16			12 000	12 150	12 050	12 200	11 850	11 650	12 000	11 700	10 700	16
18				10 250	10 300	10 350	9 900	10 150	10 050	10 050	10 100	18
20					8 800	8 800	8 800	8 600	8 700	8 750	8 650	20
22					7 700	7 550	7 700	7 800	7 700	7 550	7 400	22
24						6 550	6 850	6 800	6 700	6 550	6 400	24
26							6 000	6 000	5 850	5 750	5 650	26
28							5 350	5 300	5 200	5 050	4 950	28
30								4 700	4 600	4 450	4 350	30
32								3 350	4 100	3 950	3 850	32
34									3 650	3 500	3 400	34
36										3 100	3 000	36
38											2 650	38
40											2 350	40

* Special Conditions Or Wire Rope Required

This information is not for crane operation. Operator must refer to the in-cab information for crane operation. Rated lifting capacities shown on fully extended outriggers do not exceed 75% of the tipping loads and on tires do not exceed 65% of the tipping loads.

Fly Attachment Lift Capacity Charts – Optional (Metric)

3 856kg Counterweight – Fully Extended Outriggers – 360° Rotation (All Capacities Are Listed In Kilograms)					
42.67m Main Boom Length 2° Fly Offset			42.67m Main Boom Length 15° Fly Offset		
Radius (ft)	Fly Length (m)		Radius (ft)	Fly Length (m)	
	10.67	17.68		10.67	17.68
12	5 500		12		
14	5 500	3 850	14	5 200	
16	5 500	3 750	16	5 100	
18	5 500	3 700	18	5 000	3 300
20	4 750	3 600	20	4 900	3 150
22	3 900	3 500	22	4 200	3 050
24	3 250	3 400	24	3 500	2 950
26	2 650	2 900	26	2 900	2 850
28	2 200	2 400	28	2 400	2 750
30	1 800	2 000	30	2 000	2 300
32	1 500	1 650	32	1 650	1 950
34	1 200	1 350	34	1 350	1 600
36	950	1 100	36	1 050	1 350
38	700	900	38	850	1 100
40	500	700	40	600	850
42		500	42	400	650
44			44		500

42.67m Main Boom Length 30° Fly Offset			42.67m Main Boom Length 45° Fly Offset		
Radius (ft)	Fly Length (m)		Radius (ft)	Fly Length (m)	
	10.67	17.68		10.67	17.68
18	4 450		18		
20	4 350		20	3 950	
22	4 300		22	3 950	
24	3 750	2 550	24	3 900	
26	3 150	2 500	26	3 350	2 250
28	2 650	2 400	28	2 800	2 200
30	2 200	2 350	30	2 300	2 150
32	1 800	2 250	32	1 900	2 150
34	1 500	1 850	34	1 550	2 050
36	1 200	1 550	36	1 250	1 750
38	950	1 300	38	1 000	1 450
40	700	1 050	40	750	1 150
42	500	800	42		900
44		600	44		700
46		450	46		500

This information is not for crane operation. Operator must refer to the in-cab information for crane operation. Rated lifting capacities shown on fully extended outriggers do not exceed 75% of the tipping loads and on tires do not exceed 65% of the tipping loads.

5 216kg Counterweight – Fully Extended Outriggers – 360° Rotation (All Capacities Are Listed In Kilograms)							
42.67m Main Boom Length 2° Fly Offset				42.67m Main Boom Length 15° Fly Offset			
Radius (ft)	Fly Length (m)			Radius (ft)	Fly Length (m)		
	10.67	17.68	22.56		10.67	17.68	22.56
12	5 500			12			
14	5 500	3 850		14	5 200		
16	5 500	3 750	3 000	16	5 100		
18	5 500	3 700	3 000	18	5 000	3 300	
20	5 200	3 600	3 000	20	4 900	3 150	2 850
22	4 300	3 500	3 000	22	4 600	3 050	2 650
24	3 600	3 400	2 950	24	3 850	2 950	2 450
26	3 000	3 200	2 700	26	3 250	2 850	2 300
28	2 500	2 700	2 550	28	2 750	2 750	2 150
30	2 100	2 300	2 250	30	2 300	2 600	2 050
32	1 750	1 950	1 900	32	1 900	2 200	1 900
34	1 450	1 600	1 600	34	1 600	1 850	1 800
36	1 150	1 350	1 300	36	1 300	1 550	1 500
38	950	1 100	1 050	38	1 050	1 300	1 250
40	700	900	850	40	800	1 050	1 000
42	550	700	650	42	600	850	800
44	350	500	450	44	450	650	600
46				46		500	450

42.67m Main Boom Length 30° Fly Offset				42.67m Main Boom Length 45° Fly Offset			
Radius (ft)	Fly Length (m)			Radius (ft)	Fly Length (m)		
	10.67	17.68	22.56		10.67	17.68	22.56
18	4 450			18			
20	4 350			20	3 950		
22	4 300			22	3 950		
24	4 150	2 550	2 050	24	3 900		
26	3 500	2 500	1 900	26	3 650	2 250	1 650
28	2 950	2 400	1 800	28	3 100	2 200	1 550
30	2 450	2 350	1 700	30	2 600	2 150	1 500
32	2 050	2 300	1 600	32	2 200	2 150	1 450
34	1 750	2 100	1 550	34	1 800	2 100	1 400
36	1 400	1 800	1 500	36	1 500	1 950	1 350
38	1 150	1 500	1 400	38	1 200	1 650	1 300
40	900	1 250	1 200	40	950	1 350	1 250
42	700	1 000	1 000	42		1 100	1 100
44	500	800	800	44		900	900
46		600	600	46		650	700
48		450	400	48		450	500

This information is not for crane operation. Operator must refer to the in-cab information for crane operation. Rated lifting capacities shown on fully extended outriggers do not exceed 75% of the tipping loads and on tires do not exceed 65% of the tipping loads.

14 742kg Counterweight – Fully Extended Outriggers – 360° Rotation (All Capacities Are Listed In Kilograms)									
42.67m Main Boom Length 2° Fly Offset					42.67m Main Boom Length 15° Fly Offset				
Radius (ft)	Fly Length (m)				Radius (ft)	Fly Length (m)			
	10.67	17.68	22.56	27.43		10.67	17.68	22.56	27.43
12	5 500				12				
14	5 500	3 850			14	5 200			
16	5 500	3 750	3 000		16	5 100			
18	5 500	3 700	3 000	2 350	18	5 000	3 300		
20	5 400	3 600	3 000	2 350	20	4 900	3 150	2 850	
22	5 300	3 500	3 000	2 350	22	4 750	3 050	2 650	2 100
24	5 150	3 400	2 950	2 200	24	4 650	2 950	2 450	1 950
26	5 000	3 300	2 700	2 050	26	4 550	2 850	2 300	1 800
28	4 550	3 200	2 550	1 850	28	4 350	2 750	2 150	1 650
30	4 000	3 100	2 350	1 750	30	4 150	2 700	2 050	1 550
32	3 500	2 950	2 200	1 600	32	3 650	2 600	1 900	1 400
34	3 100	2 800	2 100	1 500	34	3 250	2 550	1 800	1 300
36	2 750	2 650	1 950	1 400	36	2 850	2 400	1 700	1 250
38	2 400	2 550	1 850	1 300	38	2 500	2 300	1 650	1 150
40	2 100	2 300	1 750	1 200	40	2 200	2 200	1 550	1 050
42	1 850	2 000	1 650	1 100	42	1 950	2 100	1 500	1 000
44	1 650	1 800	1 600	1 050	44	1 700	1 950	1 400	950
46	1 450	1 550	1 500	1 000	46	1 500	1 700	1 350	900
48	1 250	1 400	1 300	900	48	1 300	1 500	1 300	850
50	1 100	1 200	1 150	850	50	1 100	1 300	1 250	800
52		1 050	1 000	800	52		1 100	1 050	750
54		900	850	800	54		950	900	700
56		750	700	700	56		800	750	700
58			550	500	58			600	600
60			400		60			450	450

This information is not for crane operation. Operator must refer to the in-cab information for crane operation. Rated lifting capacities shown on fully extended outriggers do not exceed 75% of the tipping loads and on tires do not exceed 65% of the tipping loads.



For Rental Inquiries Please Call (800) 335-3148 Or Visit Us On The Web At Southwaycrane.com

5460 (supersedes 5424)–0506–N3

39

14 742kg Counterweight – Fully Extended Outriggers – 360° Rotation (All Capacities Are Listed In Kilograms)									
42.67m Main Boom Length 30° Fly Offset					42.67m Main Boom Length 45° Fly Offset				
Radius (ft)	Fly Length (m)				Radius (ft)	Fly Length (m)			
	10.67	17.68	22.56	27.43		10.67	17.68	22.56	27.43
18	4 450				18				
20	4 350				20	3 950			
22	4 300				22	3 950			
24	4 200	2 550	2 050	1 650	24	3 900			
26	4 150	2 500	1 900	1 550	26	3 900	2 250	1 650	
28	4 050	2 400	1 800	1 400	28	3 850	2 200	1 550	1 250
30	3 900	2 350	1 700	1 300	30	3 750	2 150	1 500	1 200
32	3 700	2 300	1 600	1 250	32	3 600	2 150	1 450	1 100
34	3 350	2 250	1 550	1 150	34	3 450	2 100	1 400	1 050
36	2 950	2 200	1 500	1 050	36	3 050	2 100	1 350	950
38	2 600	2 150	1 400	1 000	38	2 650	2 050	1 300	900
40	2 300	2 050	1 350	950	40	2 350	1 950	1 250	850
42	2 000	1 950	1 300	900	42	2 050	1 900	1 200	800
44	1 750	1 900	1 250	850	44		1 850	1 150	750
46	1 500	1 800	1 200	800	46		1 800	1 150	750
48		1 600	1 200	750	48		1 600	1 150	700
50		1 400	1 150	700	50			1 100	650
52		1 200	1 150	650	52			1 100	650
54		1 000	1 000	650	54				600
56			800	600	56				600
58			650	600	58				600
60				550	60				
62				350	62				

This information is not for crane operation. Operator must refer to the in-cab information for crane operation. Rated lifting capacities shown on fully extended outriggers do not exceed 75% of the tipping loads and on tires do not exceed 65% of the tipping loads.

17 917kg Counterweight – Fully Extended Outriggers – 360° Rotation (All Capacities Are Listed In Kilograms)									
42.67m Main Boom Length 2° Fly Offset					42.67m Main Boom Length 15° Fly Offset				
Radius (ft)	Fly Length (m)				Radius (ft)	Fly Length (m)			
	10.67	17.68	22.56	27.43		10.67	17.68	22.56	27.43
12	5 500				12				
14	5 500	3 850			14	5 200			
16	5 500	3 750	3 000		16	5 100			
18	5 500	3 700	3 000	2 350	18	5 000	3 300		
20	5 400	3 600	3 000	2 350	20	4 900	3 150	2 850	
22	5 300	3 500	3 000	2 350	22	4 750	3 050	2 650	2 100
24	5 150	3 400	2 950	2 200	24	4 650	2 950	2 450	1 950
26	5 000	3 300	2 700	2 050	26	4 550	2 850	2 300	1 800
28	4 700	3 200	2 550	1 850	28	4 350	2 750	2 150	1 650
30	4 450	3 100	2 350	1 750	30	4 150	2 700	2 050	1 550
32	4 050	2 950	2 200	1 600	32	3 950	2 600	1 900	1 400
34	3 600	2 800	2 100	1 500	34	3 750	2 550	1 800	1 300
36	3 200	2 650	1 950	1 400	36	3 300	2 400	1 700	1 250
38	2 850	2 550	1 850	1 300	38	2 950	2 300	1 650	1 150
40	2 550	2 400	1 750	1 200	40	2 650	2 200	1 550	1 050
42	2 250	2 300	1 650	1 100	42	2 350	2 100	1 500	1 000
44	2 000	2 150	1 600	1 050	44	2 100	2 000	1 400	950
46	1 800	1 950	1 500	1 000	46	1 850	1 950	1 350	900
48	1 600	1 700	1 450	900	48	1 650	1 850	1 300	850
50	1 400	1 550	1 400	850	50	1 450	1 650	1 250	800
52		1 350	1 300	800	52		1 450	1 250	750
54		1 200	1 150	800	54		1 250	1 200	700
56		1 050	1 000	750	56		1 100	1 050	700
58			850	700	58			900	650
60			700	700	60			750	650
62			550	550	62			600	600
64				400	64				450

This information is not for crane operation. Operator must refer to the in-cab information for crane operation. Rated lifting capacities shown on fully extended outriggers do not exceed 75% of the tipping loads and on tires do not exceed 65% of the tipping loads.



For Rental Inquiries Please Call (800) 335-3148 Or Visit Us On The Web At Southwaycrane.com

5460 (supersedes 5424)–0506–N3

41

17 917kg Counterweight – Fully Extended Outriggers – 360° Rotation (All Capacities Are Listed In Kilograms)									
42.67m Main Boom Length 30° Fly Offset					42.67m Main Boom Length 45° Fly Offset				
Radius (ft)	Fly Length (m)				Radius (ft)	Fly Length (m)			
	10.67	17.68	22.56	27.43		10.67	17.68	22.56	27.43
18	4 450				18				
20	4 350				20	3 950			
22	4 300				22	3 950			
24	4 200	2 550	2 050	1 650	24	3 900			
26	4 150	2 500	1 900	1 550	26	3 900	2 250	1 650	
28	4 050	2 400	1 800	1 400	28	3 850	2 200	1 550	1 250
30	3 900	2 350	1 700	1 300	30	3 750	2 150	1 500	1 200
32	3 700	2 300	1 600	1 250	32	3 600	2 150	1 450	1 100
34	3 550	2 250	1 550	1 150	34	3 500	2 100	1 400	1 050
36	3 450	2 200	1 500	1 050	36	3 400	2 100	1 350	950
38	3 050	2 150	1 400	1 000	38	3 100	2 050	1 300	900
40	2 700	2 050	1 350	950	40	2 750	1 950	1 250	850
42	2 400	1 950	1 300	900	42	2 450	1 900	1 200	800
44	2 150	1 900	1 250	850	44		1 850	1 150	750
46	1 900	1 850	1 200	800	46		1 800	1 150	750
48		1 800	1 200	750	48		1 800	1 150	700
50		1 700	1 150	700	50		1 700	1 100	650
52		1 500	1 150	650	52			1 100	650
54		1 300	1 100	650	54				600
56			1 100	600	56				600
58			950	600	58				600
60				600	60				
62				600	62				
64				450	64				

This information is not for crane operation. Operator must refer to the in-cab information for crane operation. Rated lifting capacities shown on fully extended outriggers do not exceed 75% of the tipping loads and on tires do not exceed 65% of the tipping loads.



For Rental Inquiries Please Call (800) 335-3148 Or Visit Us On The Web At Southwaycrane.com

5460 (supersedes 5424)–0506–N3

Link-Belt Construction Equipment Company Lexington, Kentucky www.linkbelt.com

©Link-Belt is a registered trademark. Copyright 2006. We are constantly improving our products and therefore reserve the right to change designs and specifications.

HTC-8690

Link-Belt Cranes

This material is for informational purposes only and is not intended to be a substitute for an operation manual. Only persons that are trained in the operation of heavy machinery should do so. For inquiries, call Southway Crane & Rigging, LLC at (800) 335-3148.